



DeepSIM

Seamless Evolution of Your Microscopy



**Introducing DeepSIM,
the super-resolution microscopy system that
addresses deep biological questions with ease.**

**Our goal at CrestOptics is to make super-resolution
accessible to all scientists to advance their research.
For this reason, we developed **DeepSIM**, the first
super-resolution module that is compatible with any
existing upright or inverted microscope and can be
used like a confocal microscope to facilitate access
to super-resolved deep data of biological samples.**

Three imaging modalities in one setup

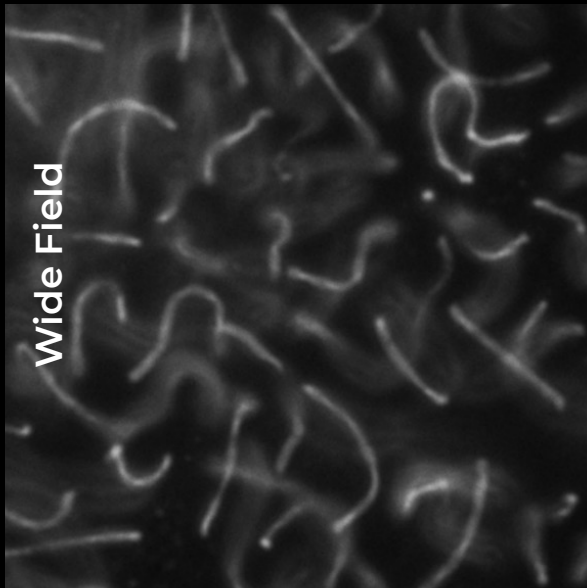

By choosing [DeepSIM technology](#), you will be able to create a modular, expandable, and highly performant system, resulting in the creation of a truly enabling technology.

The DeepSIM can be used both with CrestOptics' X-Light V3 confocal system as well as independently as a Stand-Alone system for any microscope that has a camera port.

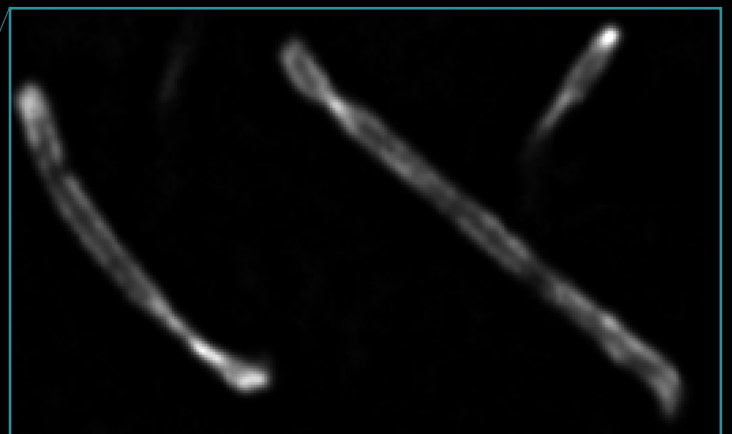
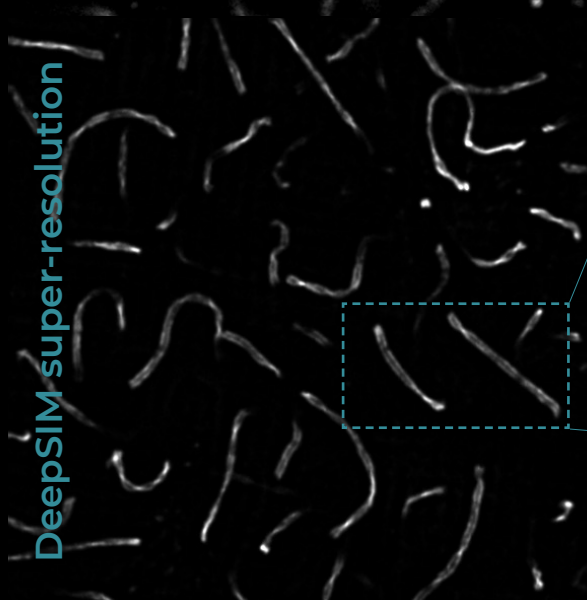
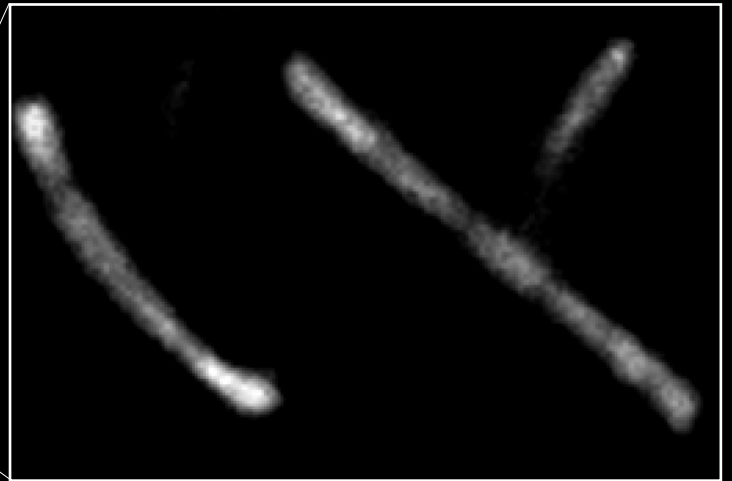

A single click to double confocal resolution

Through the use of a multi-spot structured illumination system, DeepSIM provides reliable, easy-to-use and affordable solutions to study sub-cellular structures with a XY resolution of **100 nm** without requiring any special sample preparation protocol.

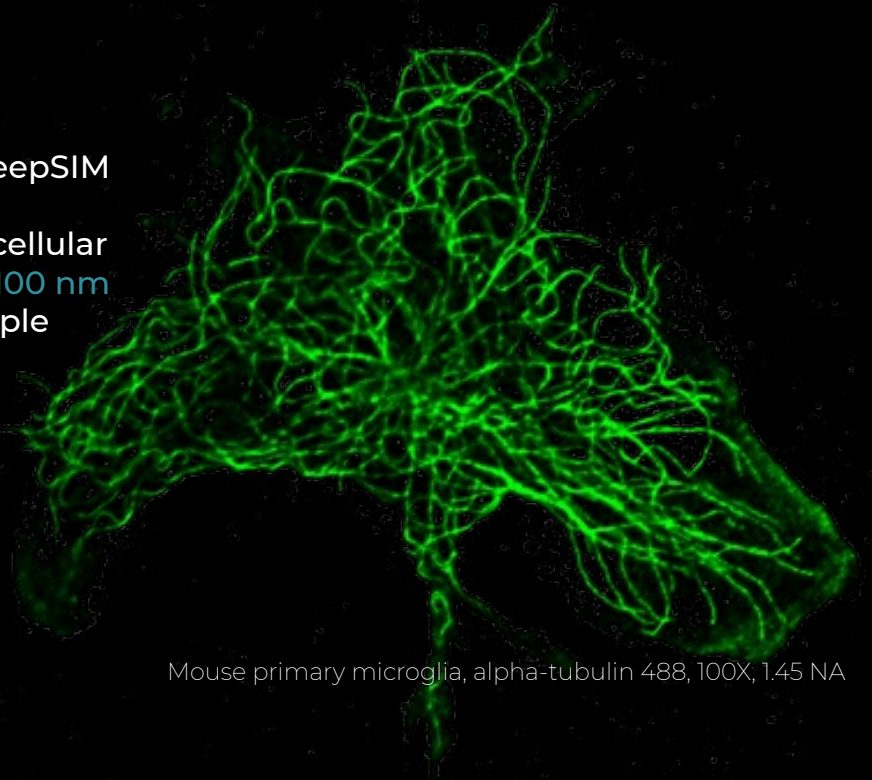

Mouse primary microglia, alpha-tubulin 488, 100X, 1.45 NA

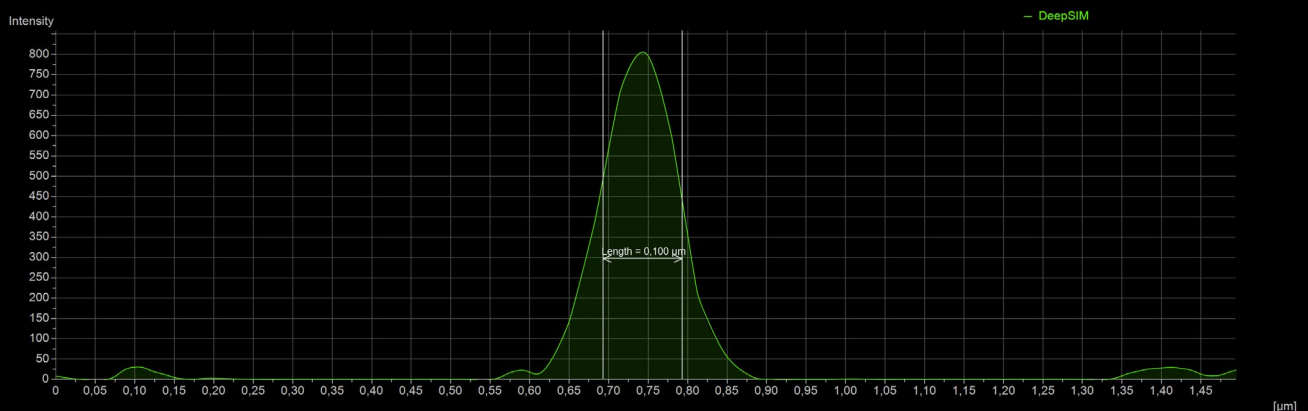
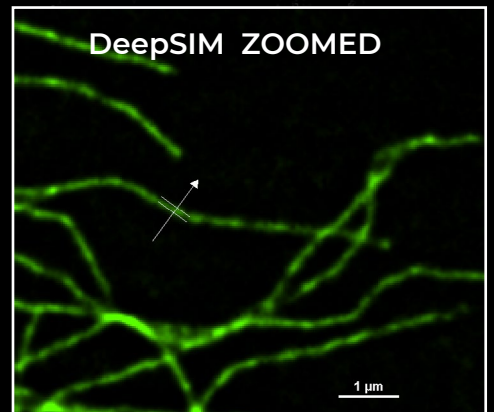
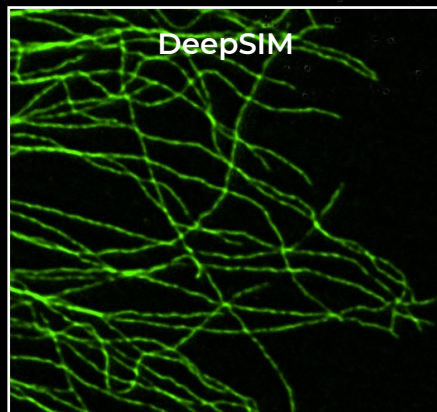
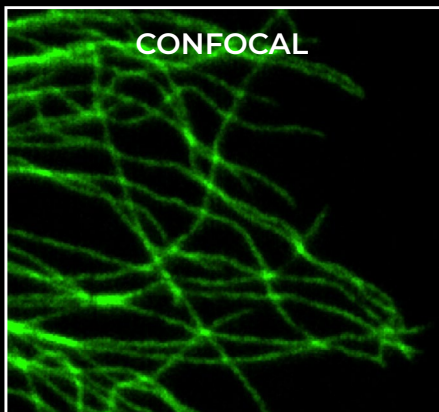

Mouse primary microglia, alpha-tubulin 488, 100X, 1.45 NA, 100 nm resolution

Three methods are available for obtaining deep data...

Mouse kidney section. Wheat Germ Agglutinin (WGA; green) and phalloidin (red) markers. 25X SiI, 1.05 NA acquired with X-Light V3 Spinning disk system.

With DeepSIM, large confocal acquisitions can be enhanced by adding a deeper level of detail thanks to **super-resolved optical sectioning** with Z resolution of up to 300 nm.

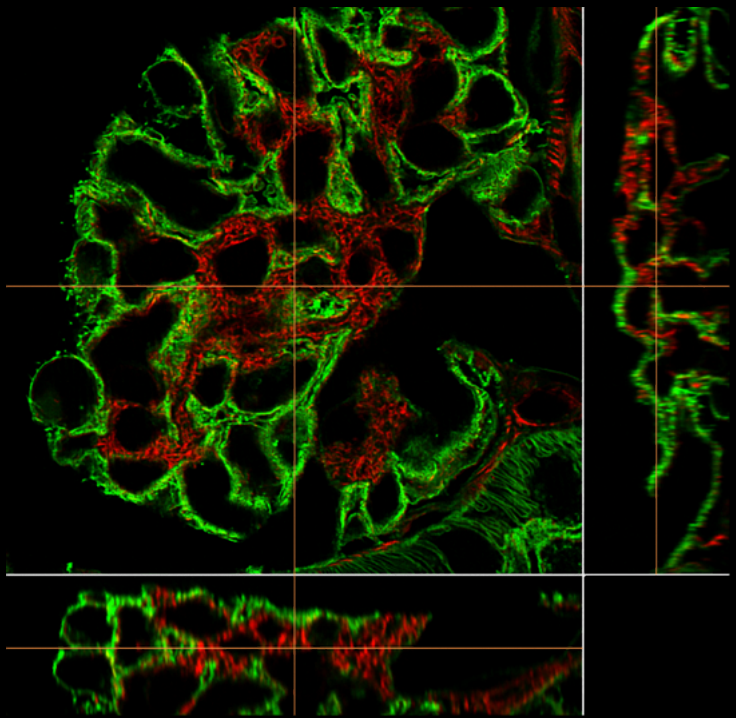
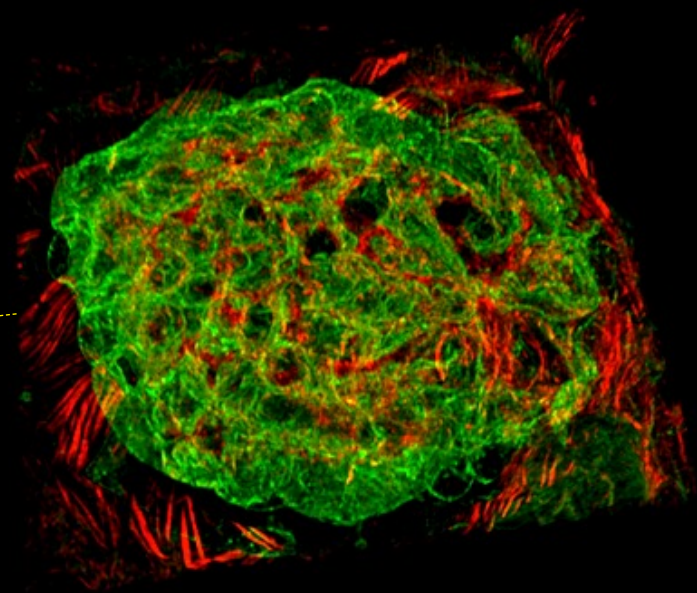
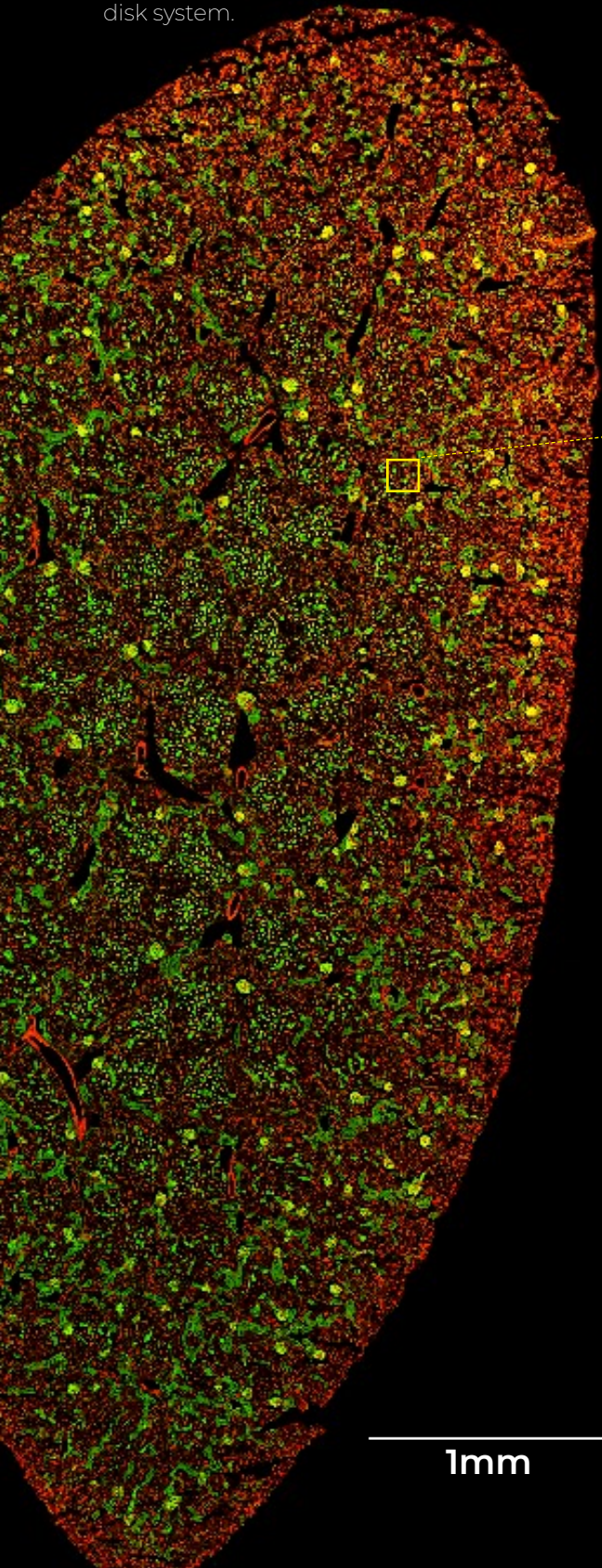

1mm

3D volume views of super-resolved glomeruli, 60X, 1.45 NA. Axial resolution is appreciable through orthogonal views.

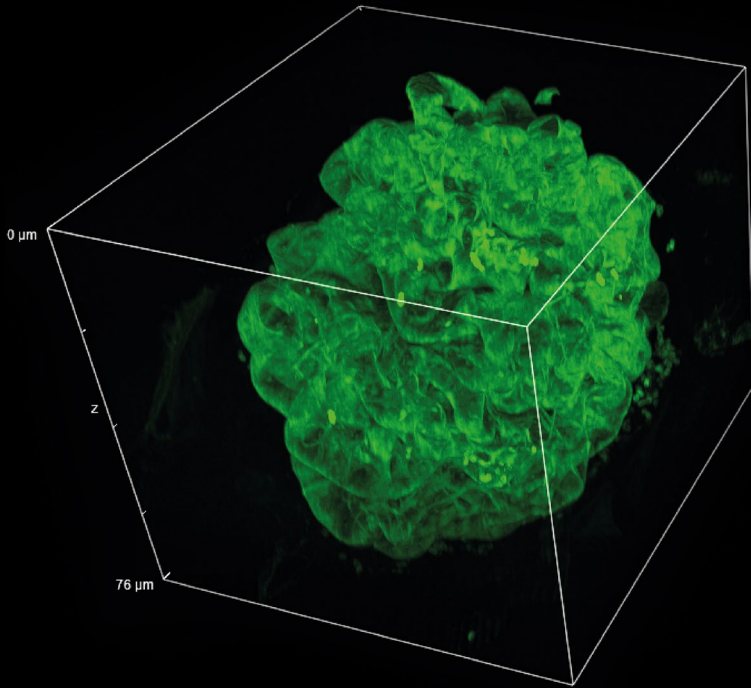

It can be used with samples with thicknesses comparable to those used in confocal microscopy, giving super-resolved data over a **depth of 50 μm** .

In this way, native heterogeneous complex samples can be investigated more thoroughly using routine preparation protocols.

Cleared mouse kidney section stained with Alexa Fluor 488 labeling blood vessels.

Z stack 76 μm and 3D rendering.

A two-fold increase in spatial resolution can be obtained using both **high magnification (60X, 100X)** and **low magnification (20X, 40X) objectives**, thereby enabling the study of complex 3D models such as tissues, spheroids, organoids, and small organisms.

Hippocampal coronal slice from Thy1-GFP mouse brain; 20X dry 0.75 NA.

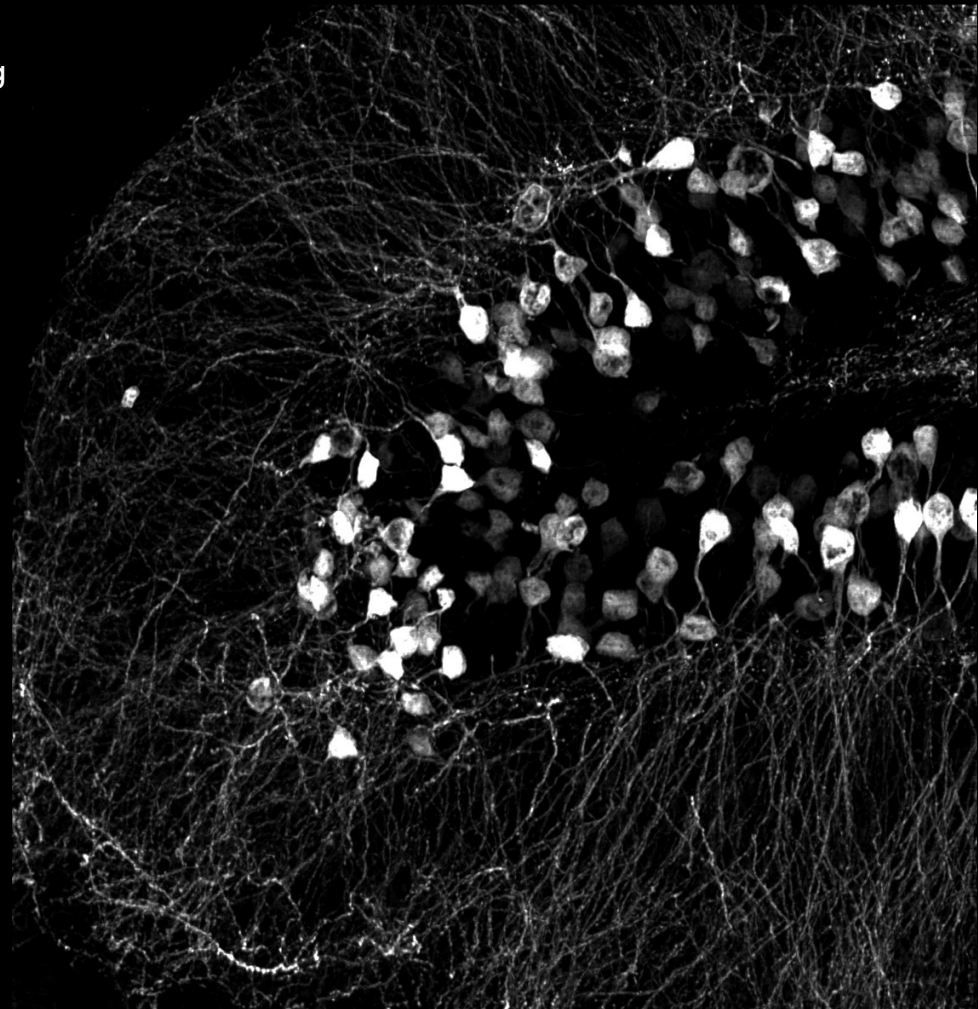

At any moment, you can find out more

In order to provide maximum flexibility in fluorophore choice and optimal multichannel imaging without spectral overlap, we have designed the instrument to operate across the **entire wavelength spectrum from 400 to 750 nm**.

By utilizing the dual camera function of the X-Light V3 spinning disk system, the DeepSIM can simultaneously acquire multiple channels, resulting in **faster acquisition times**.

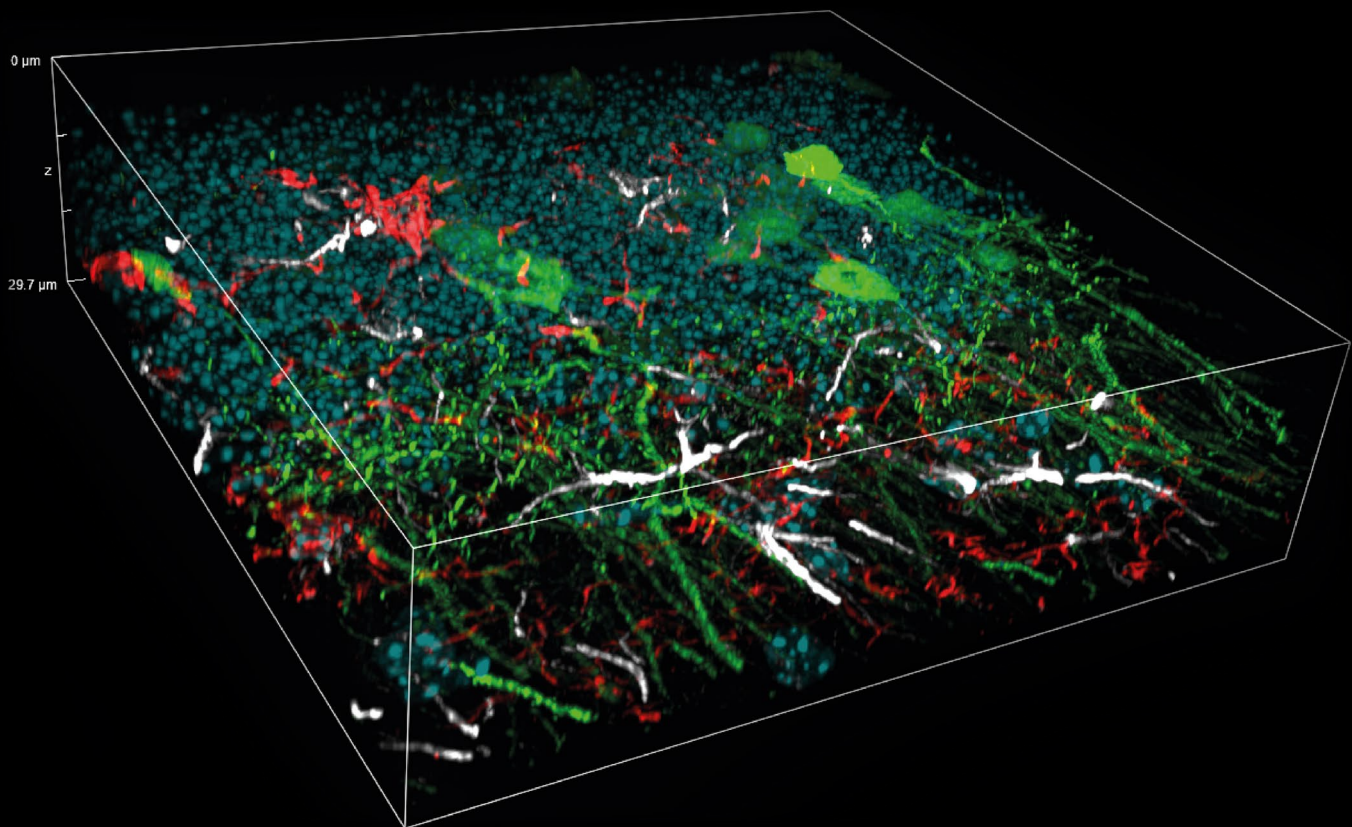

3D volume view of a mouse brain tissue section showing neurons with dendritic spines (green), microglia (red), astrocytes (white) and DNA (cyan). Total volume acquired: 30 μm . 60X, oil 1.4 NA

The DeepSIM high-speed acquisition modality allows for the capture of meaningful data at high resolution while **minimizing light exposure** and therefore

the risk of photo-toxicity. A delicate specimen can be explored using this functionality.

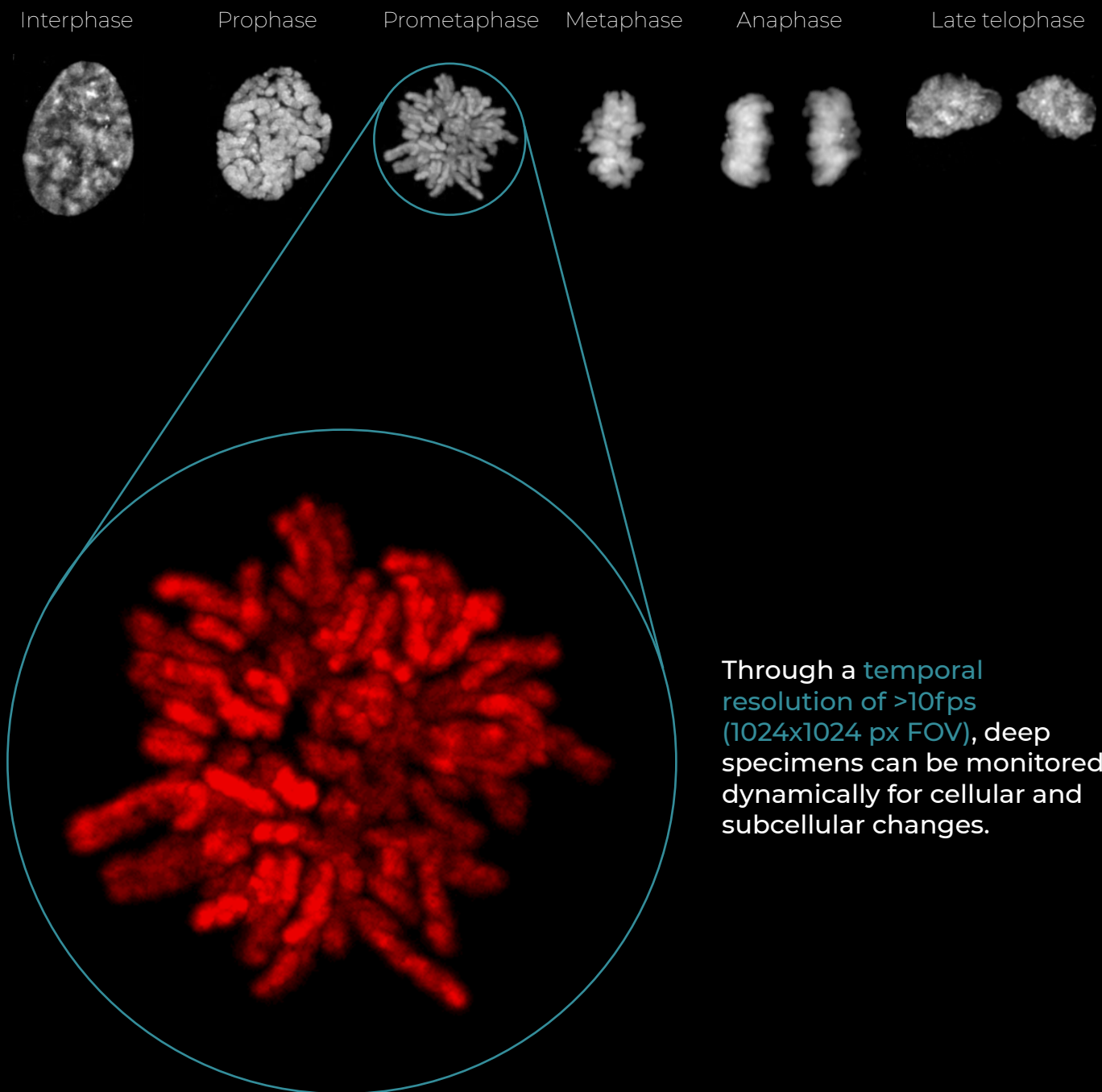

Evolution through compatibility

Stand-alone

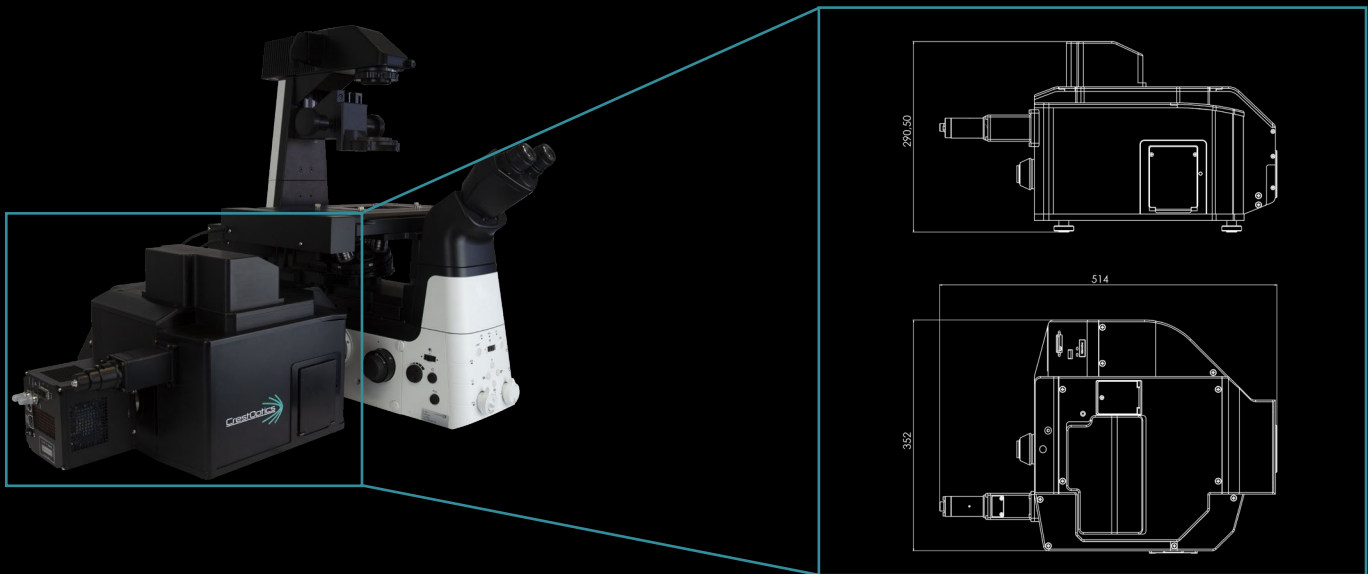

Combination with X-Light V3

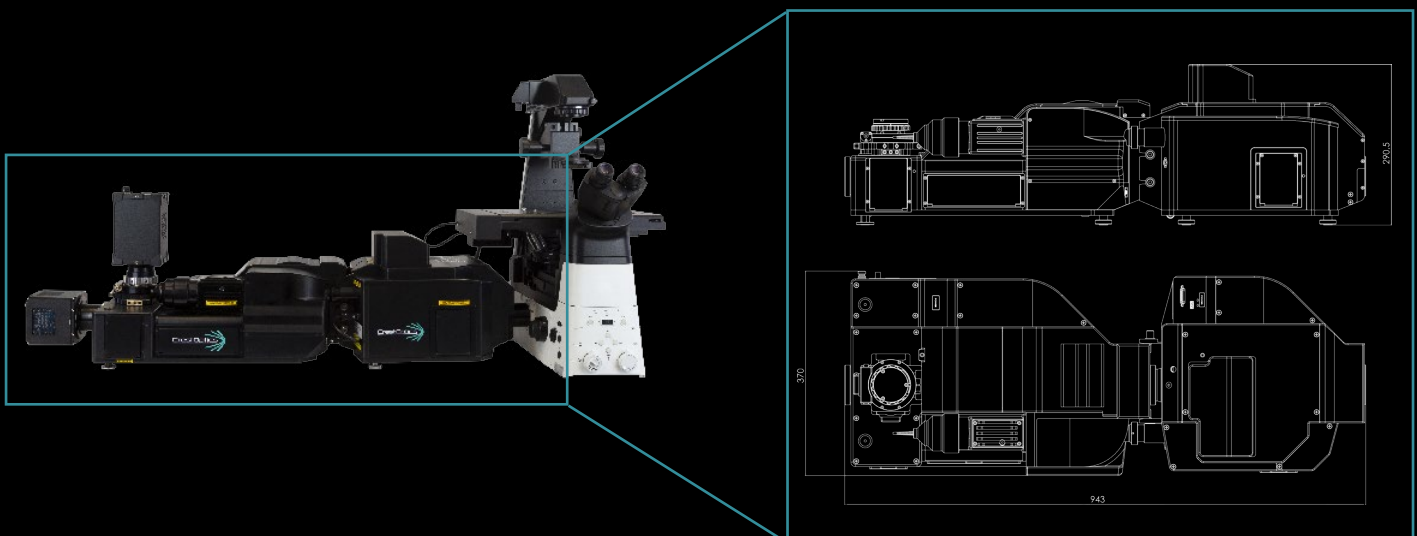

Specifications

	DeepSIM stand-alone	DeepSIM X-Light
FOV	1024x1024pixel (66x66 μm 100X 333x333μm 20X)	1024x1024pixel (66x66 μm 100X 333x333μm 20X)
Resolution	Lateral Resolution (FWHM): ~100 nm (100X NA 1.45) Axial Resolution (FWHM): ~300 nm (100X NA 1.45)	Lateral Resolution (FWHM): ~100 nm (100X NA 1.45) Axial Resolution (FWHM): ~300 nm (100X NA 1.45)
DeepSIM Acquisition speed	13fps (1024x1024px)	13fps (1024x1024px)
Laser spectral range	Excitation: 400-750 nm; emission: 400-850 nm	Excitation: 400-750 nm; emission: 400-850 nm
Objective specifications	-from 20X to 100X magnification range -high numerical aperture (NA) -plan apochromat correction	-from 20X to 100X magnification range -high numerical aperture (NA) -plan apochromat correction
Camera compatibility	Any triggerable camera having 6.5 μm pixel size	Any triggerable camera having 6.5 μm pixel size
Multi cameras option	Single camera	Dual camera option available*
Spinning disk upgrade	Stand-alone solution	Add-on compatible with CrestOptics X-Light V3
Imaging modalities	Super-resolution DeepSIM Widefield	Super-resolution DeepSIM Confocal spinning disk X-light V3 Widefield
Upgradable microscope configuration	Upright and inverted configurations	Inverted configuration
Software	μManager /VisiView® / NIS Elements	μManager /VisiView® / NIS Elements
Installation Conditions	Temperature 23 ± 5° C, Humidity 70% RH or less	Temperature 23 ± 5° C, Humidity 70% RH or less
Weight	50.7 lbs 23Kg	44 lbs 20Kg
Dimensions	13.8 (w) x 20.2 (L) x 11.4 (h) inches 352.0 (w) 514.0 (L) x 290.5 (h) mm	14.0 (w) x 17.1 (L) x 11.4 (h) inches 356.0 (w) x 435.0 (L) x 290.5 (h) mm

*Software integration in progress

Specifications and equipment are subject to change without any notice or obligation on the part of the manufacturer. November 2022 CrestOptics S.p.A.



WARNING

TO ENSURE CORRECT USAGE, READ THE CORRESPONDING MANUALS CAREFULLY BEFORE USING YOUR EQUIPMENT.



CrestOptics S.p.A.
Via di Torre Rossa 66, 00165, Roma (RM)
www.crestoptics.com
+39 06 6147496
info@crestoptics.com

Wavelength: 400-800nm
CW/Pulsed: CW
Max Average Power: 7W
IEC 60825-1:2014



DANGER – Visible and invisible laser radiation. Avoid eye or skin exposure to direct or scattered radiation.
Class 4 laser product
EN 60825-1:2014