



**ANDOR**  
an Oxford Instruments company

# Sona

sCMOS

## The Ultimate Microscopy Camera Platform for Life Science

4.2B-11 | 4.2B-6

Developmental Biology	●	●
Plasma Membrane Studies	●	●
Cell Motility		●
Intracellular Trafficking		●
Neuroimaging	●	●
FCS	●	
Organoids		●
High Content Imaging	●	
Super-resolution	●	●
Microbial Imaging	●	

### Key Specifications

- High Sensitivity: Up to 95% QE
- Fast Speeds: Up to 74 fps
- Large Field of View: Up to 32 mm
- Deep Cooled: -45°C cooling
- Protected: UltraVac™ sensor enclosure
- Flexible: 11 μm & 6.5 μm pixel sensors



andor.com

# What is Sona?

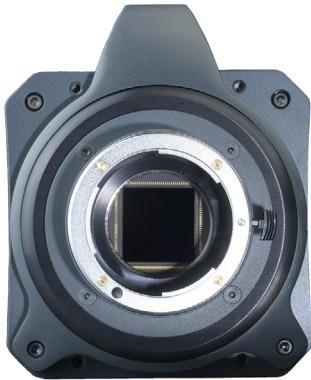

Sona is Andor's high performance, vacuum-cooled sCMOS camera platform, specifically for fluorescence microscopy. It has been designed from the ground up to deliver unparalleled performance and versatility. The Sona platform includes the **Sona 4.2B-11**, which offers an impressive **32 mm field of view**. This is complemented by the new highly versatile **Sona 4.2B-6**, which provides a balanced combination of sensitivity, exceptional speed and resolution.

## The Most Sensitive Back-illuminated sCMOS

The Sona back-illuminated sCMOS camera series features up to **95% Quantum Efficiency** and Andor's unique **vacuum cooling to -45°C**, thus minimizing noise. Back-illuminated sensors are esteemed specifically for enhanced sensitivity – it makes sense to choose the most sensitive adaption of this high end technology.

- ✓ Reduce excitation power – preserve living specimens during observation
- ✓ Reduce fluorophore concentrations – obtain more accurate physiology
- ✓ Reduce exposure times – follow faster processes

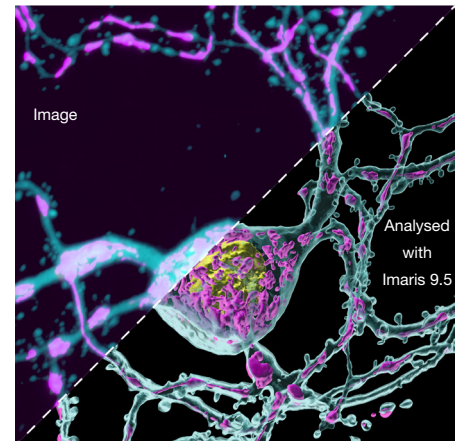

Neuron image taken using Andor sCMOS, Dragonfly, and analysed using Imaris 9.5.  
*Image courtesy of Aubrianna Decker (Gaublomme Lab) and Daniel Virga (Polleux Lab).*

## UltraVac™ - Why is Vacuum Technology Important?

As well as affording superior minimization of the noise floor, the performance longevity benefits of Andor's vacuum sensor enclosure should not be overlooked:

### Reason 1: Sensor Protection

Unless protected by vacuum, back-illuminated silicon sensors are susceptible to attack from moisture, hydrocarbons and other gas contaminants, resulting in gradual performance decline, **including QE decline**.

### Reason 2: No re-backfilling of sensor enclosure

UltraVac™ uses a hermetic vacuum seal, completely preventing any gas and moisture ingress from the outside environment. This avoids moisture condensation on the sensor and the need to return to factory for repair. Unlike other sCMOS cameras, Sona uses a vacuum sealed enclosure to protect the sensor and minimize the noise floor.

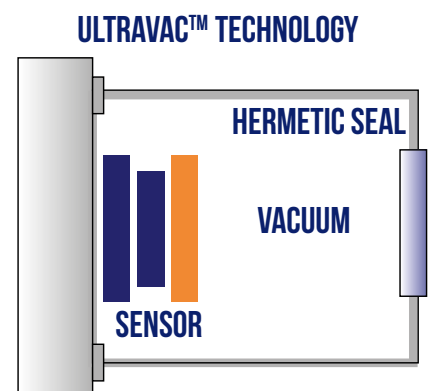

# Features and Benefits

Feature	Benefit
<b>All Sona Models</b>	
Up to 95% QE & lowest noise	Prolong live cell observations / accurately measure physiology.
Vacuum cooled to -45°C	Very weak signals require the lowest noise floor: don't be limited by camera thermal noise!
The ONLY vacuum back-illuminated sCMOS*1	Andor's proprietary UltraVac™ technology protects the sensor from (a) QE degradation, and (b) moisture condensation.
Extended Dynamic Range (EDR) mode	'One snap quantification' up to 53,000:1 signal range - measure challenging bright-dim samples such as neurons.
> 99.7% linearity	Market leading quantitative accuracy over the whole signal range – confidence of measurement in any application where signal intensity indicates local concentration.
User configurable ROI	Adapt to a range of microscope port sizes. Push frame rates and save data storage space.
Fan and water cooling as standard	Water cooling for maximum sensitivity and highly vibration sensitive set-ups, e.g. super-resolution and electrophysiology.
<b>Sona 4.2B-11 and Sona 2.0B-11</b>	
11 µm pixel	For the highest sensitivity and largest field of view.
4.2 Megapixel & 32 mm FOV, F-mount (Sona 4.2B-11)	Capture maximum field of cells, whole embryos and large tissue samples.
Anti-Glow Technology (Sona 4.2B-11)	Allows access to full 4.2 Megapixel array with long exposures – maximize field of view and sensitivity.
2.0 Megapixel & 22 mm FOV, C-mount (Sona 2.0B-11)	Smaller sensor format version for port sizes up to 22 mm. Readily adapt for use on 19 mm and 18 mm ports.
Easily adaptable to x60 and x40 objectives	Combine with the <a href="#">Magnifying Coupler Unit (MCU)</a> – preserve optical clarity over a range of sample types.
48 fps (4.2 Megapixel); 70 fps (2.0 Megapixel)	Image highly dynamic samples without signal smear - e.g. cell motility, membrane dynamics, ion flux, blood flow.
USB 3.0 ('USB 3.1 Gen 1')*7	A convenient, high speed interface.
<b>NEW Sona 4.2B-6</b>	
6.5 µm pixel	Ideal for maximum resolution at 40x and 60x.
4.2 Megapixel and C-mount	Perfect fit for modern microscopes and direct replacement for older generations of sCMOS cameras.
Low noise mode	Sona 4.2B-6 features a low noise mode which reduces the noise floor without impacting frame rate or increasing exposure times. This mode is ideal when the highest sensitivity is required.
High Speed Mode	Acquire images at high speeds of up to 74 fps in full frame 16-bit mode via CoaXPress! Boost speeds even further using regions of interest.

Cover image by Andor Technology. Rendered images created with Imaris.

# The Sona sCMOS series

## Sona 4.2B-11: A Superior Field of View

The **Sona 4.2B-11** is the ultimate detector of choice when field of view and sensitivity are required. Andor's unique technology approach enables you to usefully and uniquely access the entire 2048 x 2048 pixel array of the GSense 400 BSI sensor, offering an impressive 32 mm sensor diagonal. With the right objective matching, this can be used to harness the entire field of view available from the microscope.

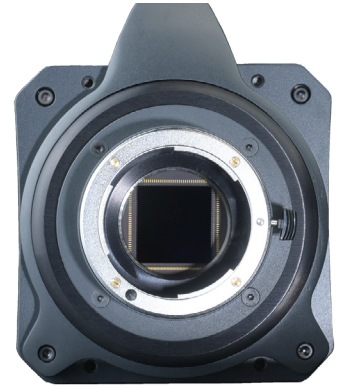

The **Sona 4.2B-11** model is highly adaptable and presents an exclusive solution for capturing extremely large fields of cells or whole embryos with exceptional clarity. Pre-configured regions of interest readily adapt for use with a range of common port sizes.

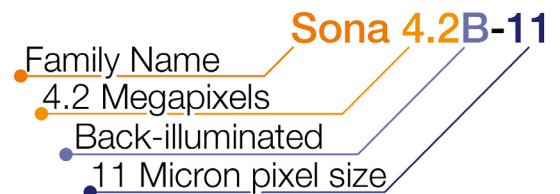

- ✓ Developmental biology – capture whole embryos
- ✓ Tissue cultures – minimize stitching, maximize throughput
- ✓ Perfect for capturing large fields of cells, embryos and tissues
- ✓ Gene editing – screen large cell cultures for successful phenotype expression
- ✓ Fluorescence correlation spectroscopy – capture more data
- ✓ High content imaging

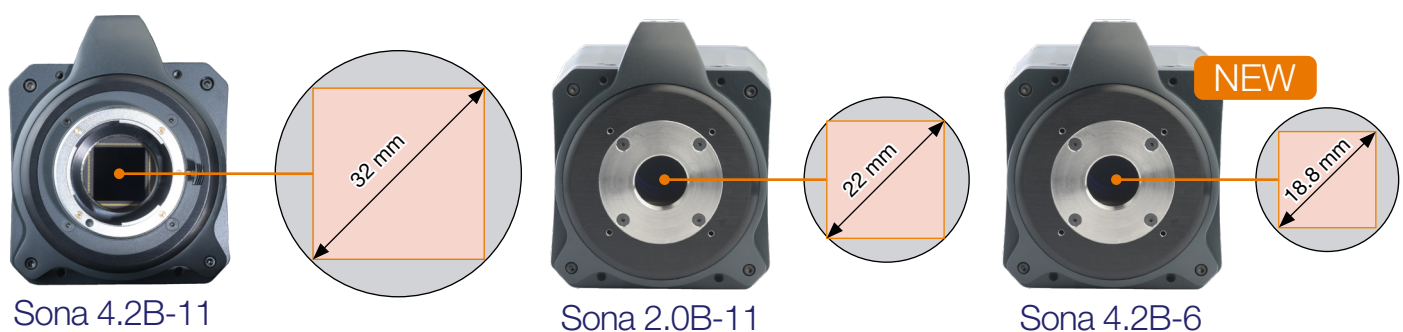

## Sona 2.0B-11: Optimised for 22 mm Microscope Ports

The **Sona 2.0B-11** has the large 11  $\mu\text{m}$  pixel and all the sensitivity of the flagship Sona 4.2B-11 model in a smaller sensor format. Sensitivity, speed and field of view has been optimized for microscopes with the common 22 mm port format.

## Sona 4.2B-6: Sensitivity, Speed and Resolution

**Sona 4.2B-6** is the most sensitive back-illuminated camera available for applications requiring **higher speeds and spatial resolution** than the Sona 4.2B-11. The 2048x2048 sensor array and **smaller 6.5 µm pixel** are ideally suited to 40x and 60x magnification and standard microscope port sizes.

For low light applications, simply having a fast detector is not enough! Sona 4.2B-6 provides the sensitivity and low noise floor, making it possible to image live cell applications at high frame rates with high signal to noise. The sensitivity combines superbly with **high frame rates**, providing full range 16-bit images, at **up to 74 fps** via CoaXPress.

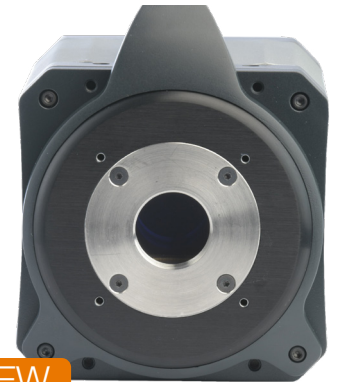

NEW

**Sona 4.2B-6**

- Family Name
- 4.2 Megapixels
- Back-illuminated
- 6.5 Micron pixel size

- ✓ Developmental biology - capture whole embryos in full clarity
- ✓ Neuroimaging - image neurons with high resolution and the widest possible dynamic range
- ✓ Plasma membrane studies - observe events at this vital interface
- ✓ Intracellular trafficking - track the inner processes of the cell
- ✓ Organoids - unravel cell connectivities

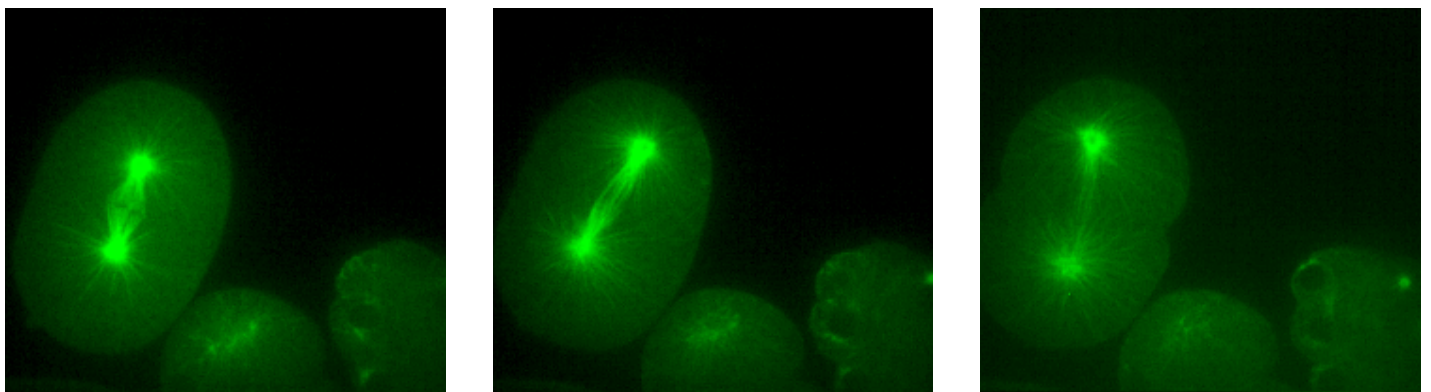

A series of frames from an image sequence of *C. elegans* cells undergoing mitosis. Images from Andor Technology.

### Sona - The Ideal Upgrade to the Latest Detector Technology

The new Sona series is a perfect opportunity to upgrade from older interline CCD or previous generations of front-illuminated sCMOS cameras and benefit from the latest detector technology:

- ✓ More pixels: improved resolution
- ✓ Higher sensitivity: see much more image information
- ✓ Large field of view: capture more in each image
- ✓ Higher speeds: get improved temporal resolution of cellular processes
- ✓ UltraVac™ technology provides deep cooling for lowest thermal noise and the ultimate sensor chamber integrity

Contact your local Andor representative to arrange a demo.

# Key Features | Sona 4.2B-11

## The Largest possible field of view

Sona 4.2B-11 is the detector of choice when field of view is required. The 32 mm sensor is 62% larger than other competing sCMOS cameras. Andor's unique Anti-Glow technology allows full use of the sensor array without sensor edge glow impacting image data.

*"We finally bought the Sona because of the usage of wider sections of the chip and thus larger field of view for FCS and imaging in light sheet microscopy"*

- Professor Thorsten Wohland, National University of Singapore.

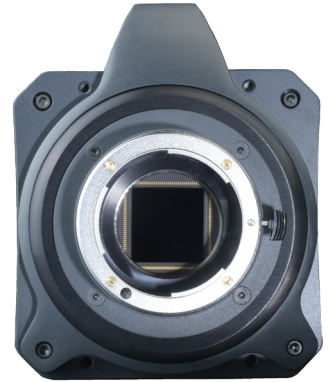

- Family Name **Sona 4.2B-11**
- 4.2 Megapixels
- Back-illuminated
- 11 Micron pixel size

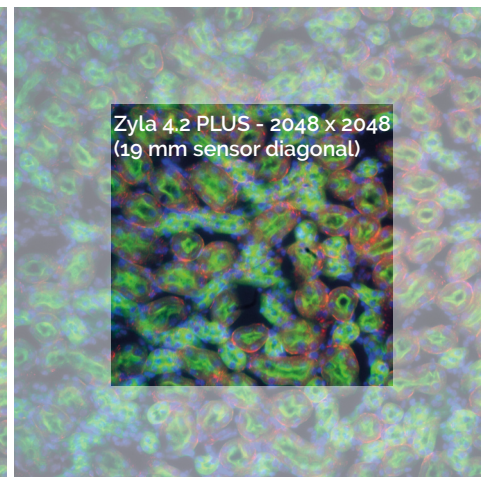
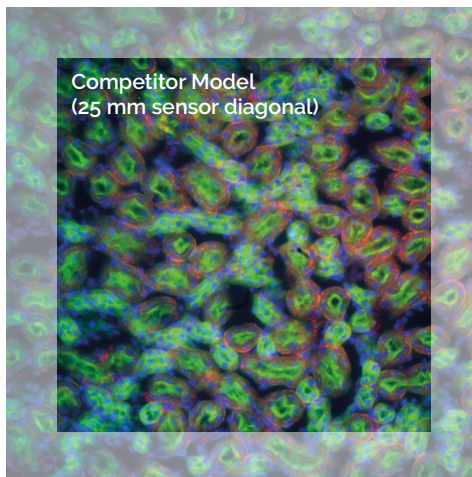
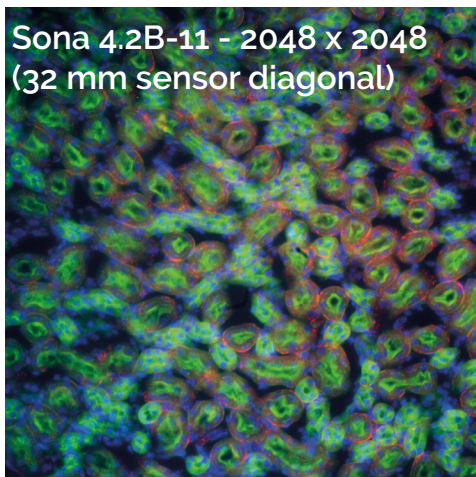

## Perfect Match for High Magnification Applications

The Sona 4.2B-11 is well matched to 100x magnification experiments. Studies of fine cellular structures using techniques such as TIRF, super-resolution localisation or confocal can be perfectly resolved. Imaging of bacterial and yeast cells also require high magnification and are inherently difficult due to the low signal levels present. The high sensitivity of Sona is perfectly suited to these applications and provides the additional benefit of a wide field of view, making it possible to screen and capture more image data in each snap.

# Application Focus | Sona 4.2B-11

## Developmental Biology

Imaging has been instrumental for following the entire lifespan of organisms to track fates of developing cells, tissues and organs. Whole-embryo and whole-body imaging of well-established model organisms including the zebrafish and *C. elegans* let us understand interconnected functional networks that shed light on nerve impulse propagation in neural circuits or ventricular pacemakers in heart models.

Sona 4.2B-11 is the ideal solution when sensitivity and the widest possible field of view are required for imaging in developmental studies. Read more in our [Learning Center](#).

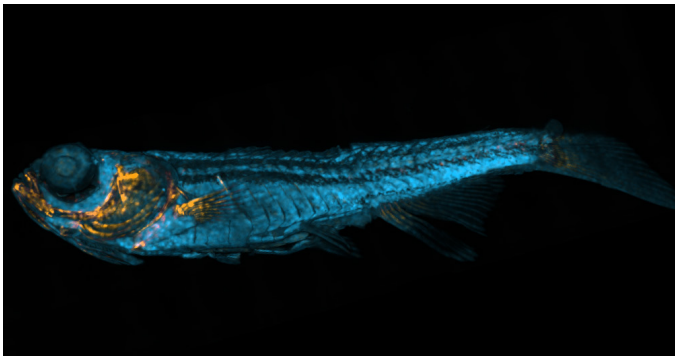

Zebrafish stitched 3D confocal image at 60x using Sona on Dragonfly and analysed using Imaris. Sample prepared by Marco Tarasco, CCMAR (Centro de Ciências do Mar / Centre for Marine Sciences) – Universidade do Algarve. Image from Andor Technology.

## Gene Editing

Recent years have seen a gradual increase in the number of studies related to Crispr-Cas9 system where this novel and versatile tool has been used with great precision for DNA editing and a multitude of applications that can benefit from this.

The best in class sensitivity offered by the back-illuminated deep cooled Sona sCMOS cameras are well suited to imaging of Crispr-Cas9 constructs, ideal for fast and sensitive detection of light emitted by labelled DNA/RNA or related proteins involved in strand cleavage and modification of the existing genetic code. The large field of view also permits screening of large cell cultures for successful gene edits. Read more in our [Learning Center](#).

## Neuroscience Imaging

Neuroscience research includes all aspects of the nervous system from the fundamentals of how memory is formed to our consciousness. Moreover, to understand disorders that affect development, and the underlying processes of neurodegenerative diseases e.g. Alzheimer's and Parkinson's. Experiments tend to be diverse in nature, often integrating several experimental methods to help provide a more complete understanding of poorly characterised neural pathways or processes.

Imaging neurons can be challenging, requiring cameras that are not only sensitive but fast. Sona 4.2B-6 is the ideal solution for most experiments, where sensitivity and speed are combined with dynamic range and resolution providing highly resolved images. For the study of wider networks of cells, or for the highest possible dynamic range, the Sona 4.2B-11 may be the preferred option.

## FCS

Florescence Correlation Spectroscopy (FCS) is a powerful technique based on the analysis of fluctuations of fluorescence intensity over time. This can be used to provide insight into many biochemical parameters such as diffusion, size, shape and concentrations of labelled molecules.

A key requirement of these experiments are highly sensitive and fast detectors with large sensor sizes so that the temporal intensity fluctuations can be captured effectively.

Sona 4.2B-11 provides the best possible solution for many FCS experiments. The largest possible sensor area, high sensitivity and high speed are complemented by class leading linearity, which allow the most accurate measurements.

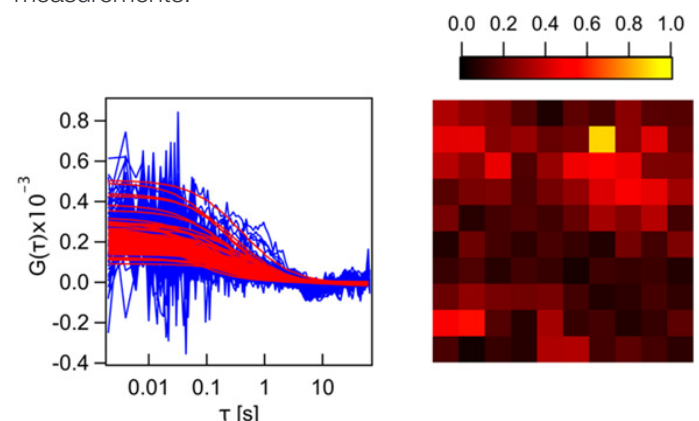

FCS data courtesy of Wohland lab, National University of Singapore.

# Key Features | Sona 4.2B-6

## Fast High Dynamic Range (16-bit) Mode

This mode is the most flexible and suitable for most applications offering a high frame rate as well as a high dynamic range. High speeds of up to 74 fps can be achieved using CoaXPress which is up to 20% faster than other cameras that use the same sensor.

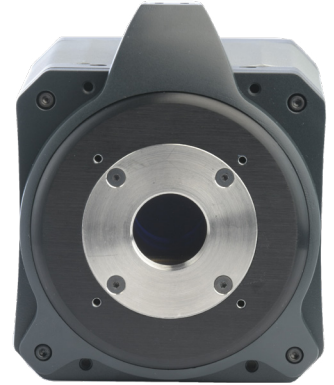

*"With the Sona we did not have to sacrifice a large field of view to achieve high frame rate readout speeds"*

- Eric Peterson, Department of Chemistry, Utah University

- Family Name **Sona 4.2B-6**
- 4.2 Megapixels
- Back-illuminated
- 6.5 Micron pixel size

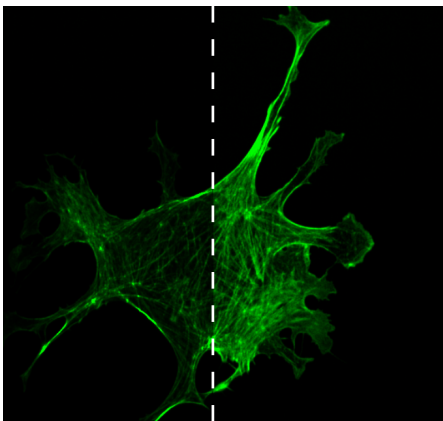

BPAC cell, AlexaFluor488-Phalloidin.  
Left; HDR mode. Right; low noise mode.  
Image from Andor Technology.

## Low Noise (12-bit) Mode

Sona 4.2B-6 features a 12-bit low noise mode that uses correlated multi-sampling to reduce read noise to  $1.2e^-$ . Unlike other approaches that achieve low noise at the expense of frame rate or through frame averaging, Sona provides low noise at high speeds without increased exposure time. This is critical for making accurate measurements in live cell imaging.

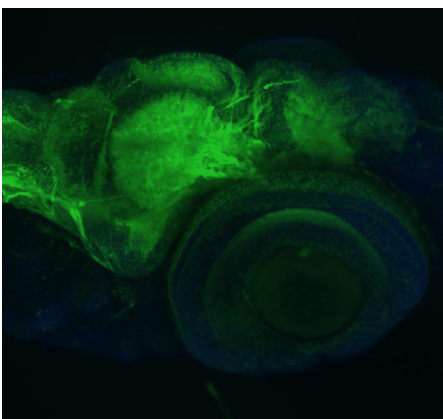

Zebrafish imaged using Sona 4.2B-6, Dragonfly confocal system and Leica DMI8 (25x). Sample prepared by Marco Campinho, CCMAR (Centro de Ciências do Mar / Centre for Marine Sciences) – Universidade do Algarve. Image from Andor Technology.

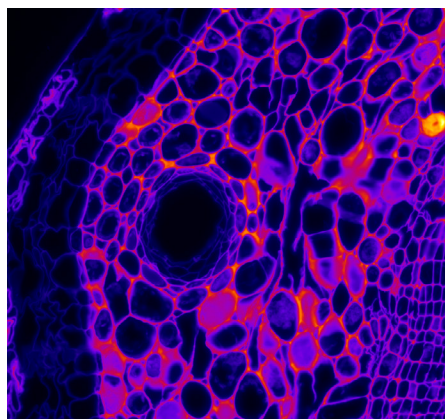

Ginkgo biloba captured using High Speed High Dynamic Range mode of Sona 4.2B-6 on Nikon Ti2 Microscope. Image courtesy of Matt Renshaw, Francis Crick Institute, London.

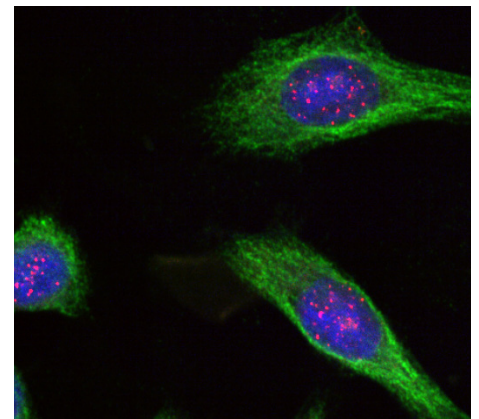

HeLa cells labelled with GFP and DAPI captured using low-noise mode of Sona 4.2B-6 on Leica DMI8 microscope at 60x. Sample prepared in Álvaro Tavares Lab, (Center Biomedical Research) – Universidade do Algarve. Image from Andor Technology.



# Application Focus | Sona 4.2B-6

## Developmental Biology

Imaging has been instrumental for following the entire lifespan of organisms to track fates of developing cells, tissues and organs. Whole-embryo and whole-body imaging of well-established model organisms including the zebrafish and *C. elegans* let us understand various interconnected functional networks that shed light on nerve impulse propagation in neural circuits or ventricular pacemakers in heart models. Read more in our [Learning Center](#).

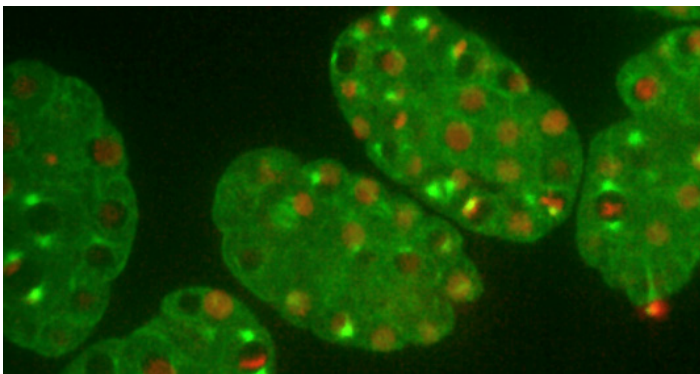

The early development of *C. elegans*, embryos labelled with GFP and mCherry, captured at 60x with Sona 4.2B-6. *Image Andor Technology.*

## Cell Motility

Cell motility is required for many important physiological processes during the cell development cycle, from the development of the embryo itself, tissue repair and cell migration. Cell motility studies can cover the finer details of how the cytoskeleton is involved in processes right through to larger scale migration at a whole cell level.

These studies are challenging from an imaging viewpoint. Detectors need to be sensitive enough to capture such events with high temporal and spatial resolution. Sona 4.2B-6 has the required qualities to fulfill these needs. High sensitivity allows the Sona to run at rapid frame rates at high resolution.

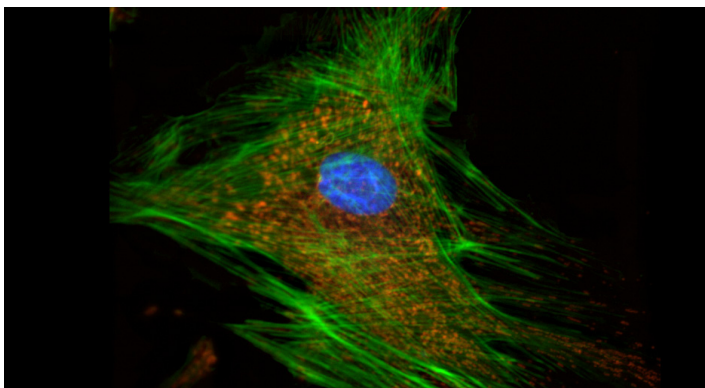

BPAAE cell, MitoTracker Red™ CMXRos, Alexa Fluor™ 488 phalloidin, DAPI, from Sona 4.2B-6 in low noise mode. *Image Andor Technology.*

## Plasma Membrane Dynamics

Analysis of phenomena associated with the plasma membrane is crucial for a large number of biological models involving cell adhesion, cell-to-cell communication, signal transduction, as well as cell fate differentiation.

The plasma membrane can be imaged in many ways, which can involve direct membrane labelling with lipophilic or voltage sensitive dyes. Rapid remodelling of the plasma membrane can be imaged with the rapid frame rate, highly sensitive back-illuminated Sona cameras, perfectly suited to the low light conditions inherent to TIRF Microscopy. Read more in our [Learning Center](#).

## Intracellular Trafficking

Without mechanisms to allow ongoing traffic of molecules, the cell's finely tuned machinery would immediately grind to a halt. Fast and sensitive imaging is crucial for studies of endosome cycling, Golgi vesicles pathways, axonal transport, hormone release or synaptic vesicle pool replenishment.

Andor sCMOS cameras have for many years been the detector of choice for experiments involving imaging of cellular traffic. The new Sona 4.2B-6 models, with their sensitivity, resolution and speed, are ideal for tracking intricate events and dependencies occurring within the cell's vital transport and communications networks. Read more in our [Learning Center](#).

## Organoid Studies

An increasing number of researchers are turning to organoids in order to study complex cellular interactions and behaviors that cannot be seen from conventional 2-dimensional cell tissue experiments. Organoid studies are proving to be effective in improving our understanding of diseases, in particular cancer. High sensitivity detectors are important for these studies so that the subtle yet vital cellular interactions can be captured.

Sona 4.2B-6 is perfectly suited to such studies providing exceptional sensitivity and resolution so that even the most complex image data can be accurately modeled.

# The Sona sCMOS Series

## Quantitative Accuracy

### Why do we need superb quantitative accuracy?

An increasing number of applications rely on accurate quantitative information rather than the image detail alone. Any measurements where intensity correlates to quantity or concentration will benefit from more accurate detectors. Andor have implemented enhanced on-camera intelligence to deliver a market leading linearity of > 99.7%. This means that the Sona series can provide the most accurate and precise measurements possible.

Applications that will benefit from this superb quantitative accuracy include:

- ✓ Measuring physiological parameters such as calcium, cAMP or PIP3 levels
- ✓ FRET analysis such as distance or co-localization measurements at the nanometer scale
- ✓ Gene expression analysis with fusion proteins
- ✓ Localization super-resolution microscopy to achieve a better gaussian fit

## Dynamic Range

The Sona camera series offers an Extended Dynamic Range (EDR) functionality, supported by a 16-bit data range. Harnessing an innovative 'dual amplifier' sensor architecture, we can access the maximum pixel well depth AND the lowest noise simultaneously, ensuring that we can quantify extremely weak and relatively bright signal regions in one snap. This functionality is useful for imaging and quantifying many challenging samples, such as neurons.

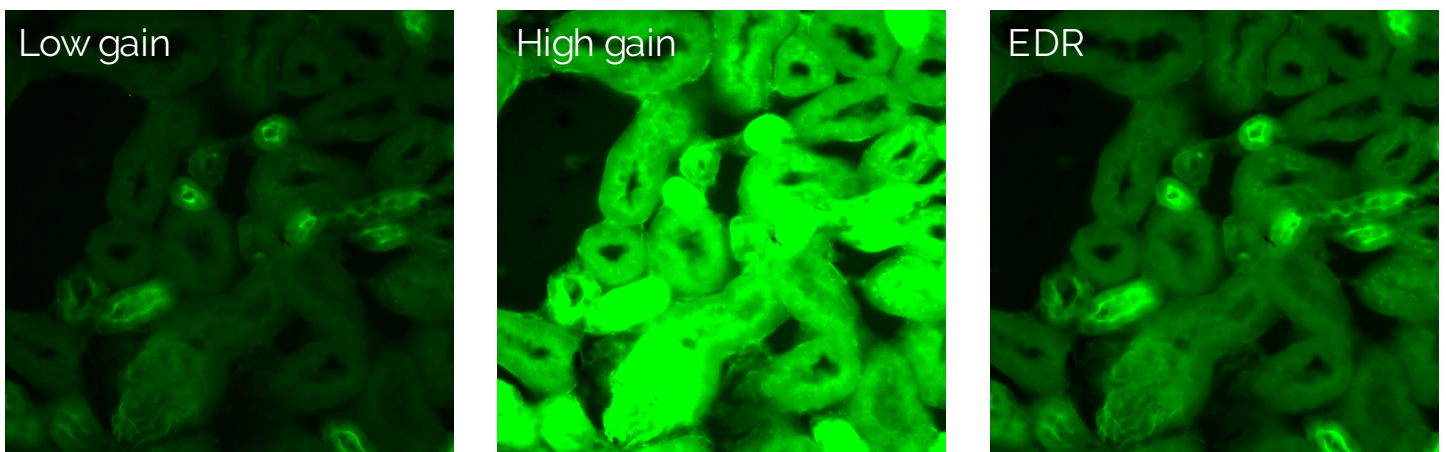

Above: The same image compared under different modes.

Low gain - captures brighter regions and accesses the max. pixel well depth.

High gain - captures dim regions with minimum noise floor.

Extended Dynamic Range - captures and quantifies both high and low signal regions, combining lowest noise and maximum pixel well depth.

# EMCCD or Back-Illuminated sCMOS?

Ever since the first sCMOS cameras were introduced by Andor, many have made comparisons with Electron Multiplying CCD (EMCCD) cameras to determine their suitability for different applications. The arrival of back-illuminated sCMOS cameras has seen renewed interest in comparisons of relative performance against EMCCD once more, as well as with the previous generations of sCMOS cameras.

sCMOS cameras offer **low noise and high speed**, making them well suited to many applications and have become the most common detector type for microscopy.

With the latest generation of back-illuminated cameras, sensitivity has been further improved. However, EMCCD technology still enables an unrivalled sensitivity via practically eliminating read noise and its single photon sensitivity.

For the majority of applications, when light is not in the order of single figure photons per pixel, the **benefits of sCMOS such as low noise, speed and large fields of view** make sCMOS ideally suited. For the **very lowest light applications**, such as single molecule detection, **EMCCD remains the “gold standard” detector**.

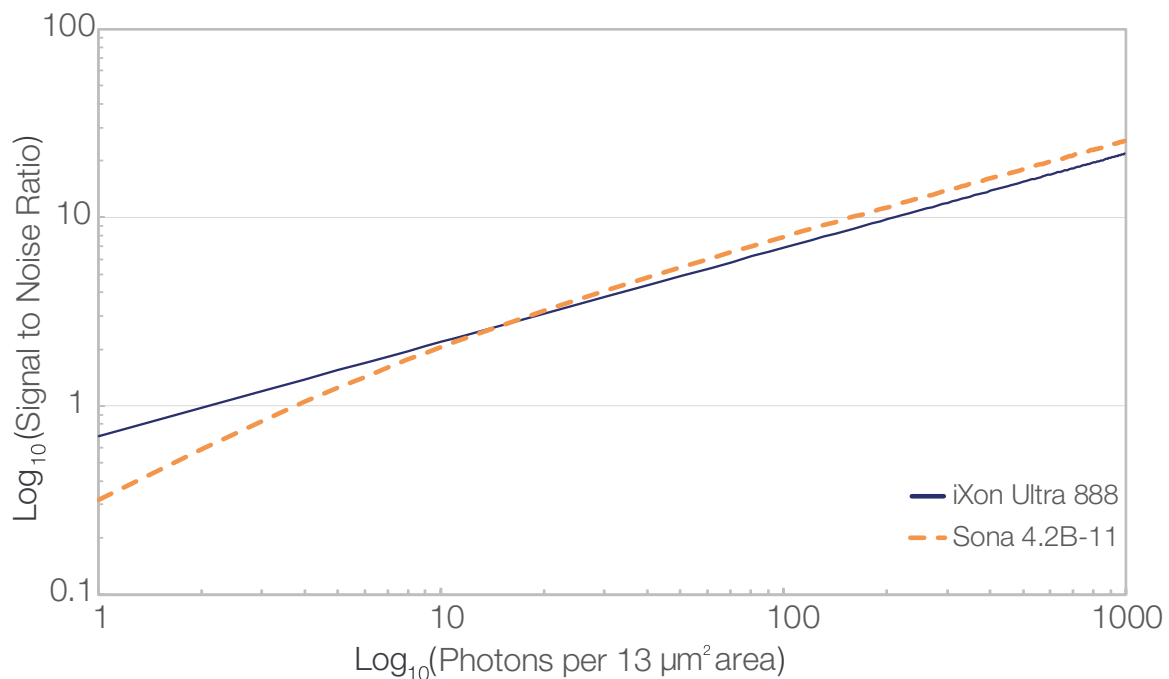

There are some single molecule application cases where Sona may be more suitable for example:

- ✓ With the larger field of view the Sona makes it possible to sample many more molecules than EMCCD e.g. in **tracking and diffusion experiments**.
- ✓ The high dynamic range of Sona means that **bright cellular markers can be imaged alongside much weaker single molecule signals**.

To find out more about this topic please read our technical article: [What is the best detector for single molecule studies?](#)

# Technical Data<sup>2</sup>

Model	Sona 4.2B-11	Sona 2.0B-11	<b>NEW</b> Sona 4.2B-6
<b>Sensor Type</b>	Back-Illuminated Scientific CMOS		
<b>Array Size</b>	2048 (W) x 2048 (H) 4.2 Megapixel	1400 (W) x 1400 (H) 2.0 Megapixel	2048 (W) x 2048 (H) 4.2 Megapixel
<b>Pixel Size</b>	11 x 11 $\mu\text{m}$		6.5 x 6.5 $\mu\text{m}$
<b>Image Area</b>	22.5 mm x 22.5 mm (31.9 mm diagonal)	15.5 mm x 15.5 mm (21.8 mm diagonal)	13.3 mm x 13.3 mm (18.8 mm diagonal)
<b>Readout Modes</b>	Rolling Shutter		
<b>Pixel Readout Rates</b>	100 MHz (High Dynamic Range mode, 16-bit) 200 MHz (Fast Speed mode, 12-bit)		310 MHz (Fast High Dynamic Range mode, 16-bit) 180 MHz (Low Noise mode, 12-bit)
<b>Quantum Efficiency<sup>3</sup></b>	up to 95%		
<b>Read Noise (e<sup>-</sup>) median</b>	1.6 e <sup>-</sup> (at any readout rate)		1.6 e <sup>-</sup> (Fast High Dynamic Range mode, 16-bit) 1.2 e <sup>-</sup> (Low Noise mode, 12-bit)
<b>Sensor operating temperature<sup>4</sup></b> Air cooled Water/liquid cooled	-25°C (up to 30°C ambient) -45°C (@16°C water)		-25°C (up to 30°C ambient) -45°C (@16°C water)
<b>Dark Current</b> Air cooled (@-25°C) Water/liquid cooled (@ -45°C)	0.7 e <sup>-</sup> /pixel/s 0.3 e <sup>-</sup> /pixel/s		0.15 e <sup>-</sup> /pixel/s 0.10 e <sup>-</sup> /pixel/s
<b>Active area pixel well depth</b>	85 000 e <sup>-</sup> (High Dynamic Range mode, 16-bit) 2600 e <sup>-</sup> (Fast Speed mode, 12-bit, bit depth limited)		55 000 e <sup>-</sup> (Fast High Dynamic Range mode, 16-bit) 1800 e <sup>-</sup> (Low Noise mode, 12-bit, bit depth limited)
<b>Dynamic Range</b>	53 000:1 (High Dynamic Range mode, 16-bit)		34 000:1 (Fast High Dynamic Range mode, 16-bit)
<b>Data Range</b>	16-bit (High Dynamic Range mode) 12-bit (Fast Speed mode)		16-bit (Fast High Dynamic Range mode) 12-bit (Low Noise mode)
<b>Linearity<sup>5</sup></b>	> 99.7%		
<b>PRNU</b>	< 0.5% (@ half-light range)		
<b>Region of Interest (ROI)</b>	User-definable, 1 pixel granularity, min. size 25 (w) x 1 (h)		User-definable, 1 pixel granularity, min. size 9 (w) x 1 (h)
<b>Pre-defined ROI</b>	1608 x 1608, 1200 x 1200, 1024 x 1024, 512 x 512, 128 x 128	1024 x 1024, 512 x 512, 128 x 128	1608 x 1608, 1200 x 1200, 1024 x 1024, 512 x 512, 128 x 128
<b>Pixel Binning (on FPGA)</b>	2 x 2, 3 x 3, 4 x 4, 8 x 8 (user-definable binning also available)		
<b>I/O</b>	O: Fire Row 1, Fire Row n, Fire All, Fire Any, Arm I: External		
<b>Trigger Modes</b>	Internal, External, External Start, External Exposure, Software		
<b>Software Exposure Events<sup>6</sup></b>	Start exposure - End exposure (row 1), Start exposure - End exposure (row n)		
<b>Image Timestamp Accuracy</b>	25 ns		
<b>PC Interface</b>	USB 3.0 <sup>7</sup>		USB 3.0 <sup>7</sup> and CoaXPress
<b>Camera Window</b>	AR coated UV grade fused silica window		
<b>Lens Mount</b>	F-mount	C-mount	

## Frame Rates

Max Frame Rate (fps)	Sona 4.2B-11		Sona 2.0B-11		Sona 4.2B-6 (USB3)		Sona 4.2B-6 (CoaXPress)	
	16-bit	12-bit (Fast Speed)	16-bit	12-bit (Fast Speed)	16-bit	12-bit (Low Noise)	16-bit	12-bit (Low Noise)
2048 x 2048	24	48	-	-	40	43	74	43
1608 x 1608	30	61	-	-	64	55	94	55
1400 x 1400	35	70	35	70	85	63	108	63
1200 x 1200	41	81	41	81	116	74	126	74
1024 x 1024	48	95	48	95	148	87	147	87
512 x 512	95	190	95	190	295	174	293	174
256 x 256	190	378	190	378	587	346	587	346
128 x 128	378	750	378	750	1165	686	1165	686
2048 x 8	5415	9747	-	-	10240	8928	15151	8928
1200 x 8	5415	9747	5415	9747	10240	8928	15151	8928

Note: frame rates do not differ if partial or full rows are selected.

## Quantum Efficiency <sup>•3</sup>

All cameras in the **Sona platform** feature back-illuminated sensor architecture which allows collection of light from the sample without circuitry blocking the photosensitive area of the detector. Thus, back-illuminated sensor technology maximises quantum efficiency.

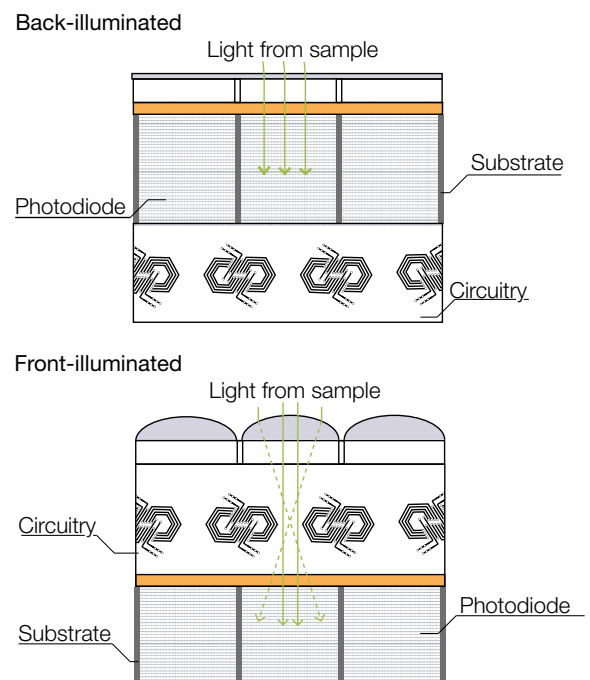
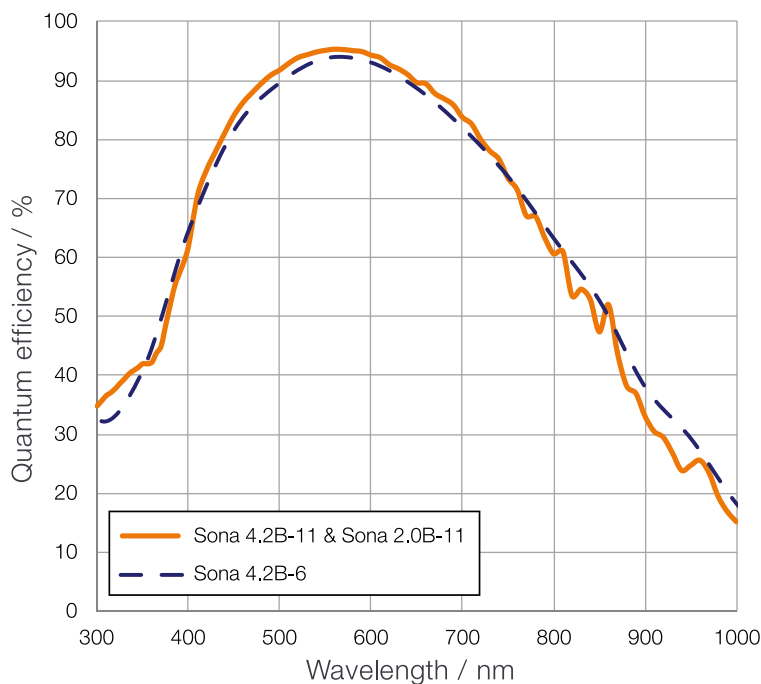

# Creating the Optimum Product for you

## Step 1. Choose the camera type

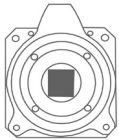

Camera Type

Description	Code
Sona 4.2B-11: 4.2 Megapixel Back-illuminated sCMOS, 11 µm pixel, 95% QE, 48 fps, USB 3.0, F-mount*	SONA-4BV11
Sona 2.0B-11: 2.0 Megapixel Back Illuminated sCMOS, 11 µm pixel, 95% QE, 70 fps, USB 3.0, C-mount	SONA-2BV11
Sona 4.2B-6: 4.2 Megapixel Back Illuminated sCMOS, 6.5 µm pixel, 95% QE, 43 fps, USB 3.0, C-mount	SONA-4BV6U
Sona 4.2B-6: 4.2 Megapixel Back Illuminated sCMOS, 6.5 µm pixel, 95% QE, 74 fps, USB 3.0 and CoaXPress, C-mount	SONA-4BV6X

\* Optional user-switchable C-Mount accessory available for use with smaller ROI sizes.

## Step 2. Select the required accessories



Accessories

Description	Order Code
MCU with 2x magnification for matching Sona to Leica microscopes	MCU-SONA-LEI
MCU with x2 magnification for matching Sona to Nikon Ti Series (TiE and Ti2) microscopes	MCU-SONA-NIK-TI
MCU with x2 magnification for matching Sona to Olympus microscopes	MCU-SONA-OLY
C-mount - convert Sona 4.2B-11 to C-mount (for use with ROIs)	ACC-MEC-11936
F-mount - replacement F-mount kit	F-MOUNT-ADP-KIT
Support feet recommended for side port mounting. Standard optical height 110 mm	TR-IXON-MNT-110
Re-circulator for enhanced cooling performance (supplied with 2x2.5 m tubing as standard)	XW-RECR
Oasis 160 Ultra compact chiller unit (tubing to be ordered separately)	ACC-XW-CHIL-160
6 mm tubing options for Oasis 160 Ultra compact chiller (2x2.5 m or 2x5 m lengths)	ACC-6MM-TUBING-2X2.5 ACC-6MM-TUBING-2X5M
Pair of barbed hose inserts for 6 mm tubing	6MM-HOSE-BARBS

## Step 3. Select the required software



Software

Sona requires one of the following software options:

**Solis Imaging A** 32-bit and fully 64-bit enabled application for Windows (8, 8.1 and 10) offering rich functionality for data acquisition and processing. AndorBasic provides macro language control of data acquisition, processing, display and export.

**Andor SDK3** A software development kit that allows you to control Andor sCMOS cameras from your own application. Available as a 32-bit or 64-bit library for Windows (8, 8.1 and 10) and Linux. Compatible with C/C++, LabView and Matlab.

**Third party software compatibility** Drivers are available for a variety of third party imaging packages. See Andor website for detail: <https://andor.oxinst.com/learning/view/article/third-party-imaging-software-support>

## Upgrade Sona 4.2B-6 with CoaXPress

Don't want to commit to CoaXPress connectivity from the outset? If preferred, order the less expensive USB 3.0-only version and later avail of a simple in-field upgrade to CoaXPress capability, using the **CHAM-UPG-CXP** code, if and when additional speed is needed. The upgrade includes CoaXPress card, cable and remote session to upgrade camera firmware and unlock CoaXPress capability. Please contact your sales representative for more information.

# Mechanical Drawings

Dimensions in mm [inches]  
(shown for C-mount)

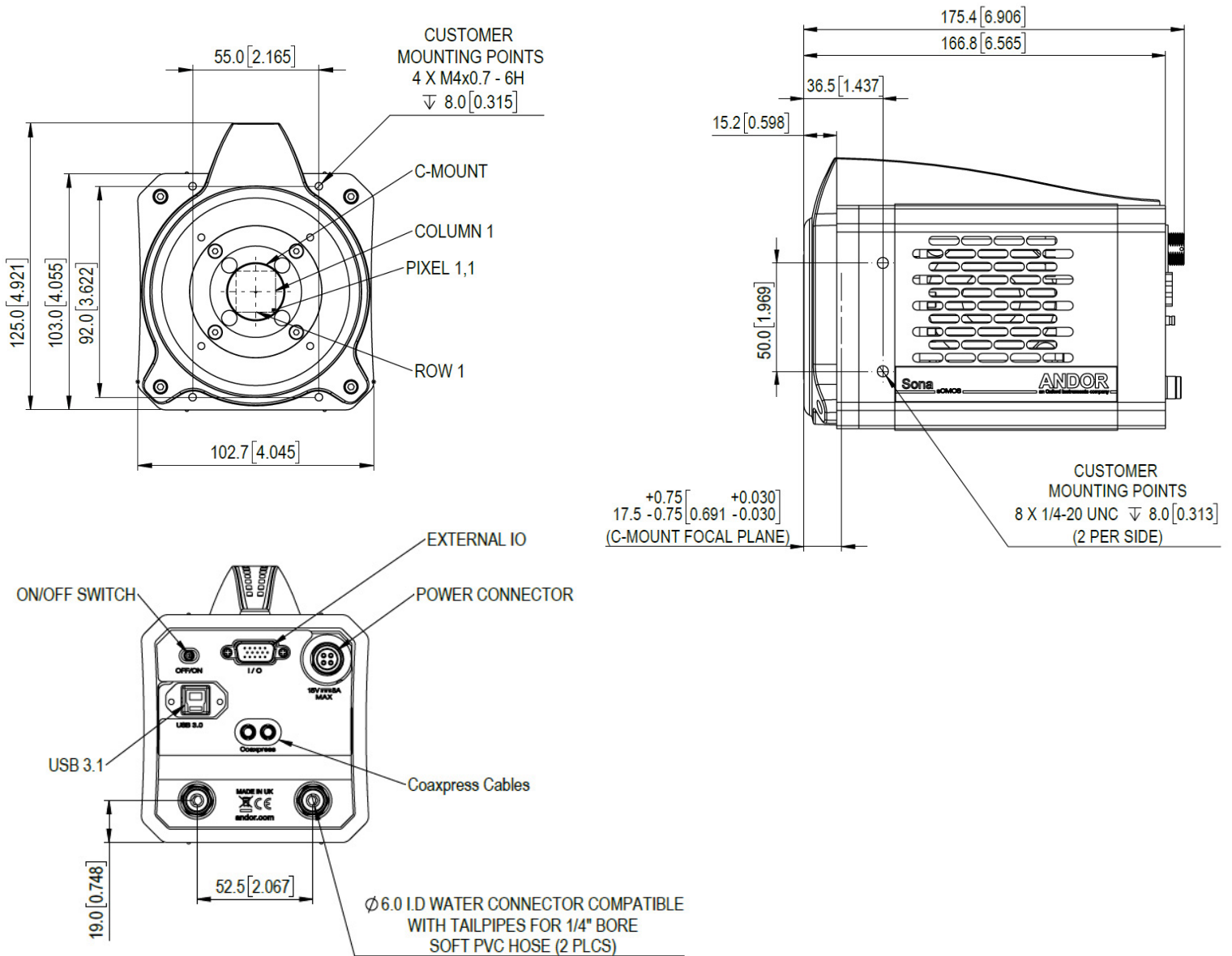

Note: Support feet are recommended for mounting on microscope side ports. Adjustable support feet. Standard optical height 110 mm, TR-IXON-MNT-110.

Note: CoaXPress connection only available with SONA-4BV6X model.

Weight: ~2.7 kg [5.95 lbs] approx.

## Have you found what you are looking for?

**Need faster frame rates?** The Zyla sCMOS platform, configured with CameraLink interface, can deliver 100 fps from a full 5.5 or 4.2 Megapixel array, faster still with sub-array selection.

**Need more sensitivity?** The iXon Life EMCCD platform offers single photon sensitivity and 95% back-illuminated QE, further boosted by cooling to -80°C. Ideal for demanding light starved applications such as single molecule biophysics.

**Need better NIR performance?** The iXon EMCCD range offers sensor options that extend QE further into the NIR region of the spectrum. Ideal for the increasingly popular range of red/NIR enhanced fluorophores, offering enhanced signal to background contrast and deeper penetration into tissues.

# Order Today

Need more information? At Andor we are committed to finding the correct solution for you. With a dedicated team of technical advisors, we are able to offer you one-to-one guidance and technical support on all Andor products.

For a full listing of our local sales offices, please see: [andor.com/contact](http://andor.com/contact)

## Our regional headquarters are:

### Europe

Belfast, Northern Ireland  
Phone +44 (28) 9023 7126  
Fax +44 (28) 9031 0792

### North America

Concord, MA, USA  
Phone +1 (860) 290 9211  
Fax +1 (860) 290 9566

### Japan

Tokyo  
Phone +81 (3) 6732 8968  
Fax +81 (3) 6732 8939

### China

Beijing  
Phone +86 (10) 5884 7900  
Fax +86 (10) 5884 7901

## Items shipped with your camera

- 1x USB 3.0 PCIe card<sup>7</sup>
  - 1x USB 3.0 Cable (3 m)<sup>7</sup>
  - 1x Multi I/O Timing Cable (BNC to D-type: 1.5 m)
  - 1x 15 V PSU
  - 1x Country specific power cord
  - 1x User manuals in electronic format
  - 1x Quickstart Guide
  - 1x Individual system performance booklet
- Sona 4.2B-6 with CoaXPress also includes:
- 1x CoaXPress 3.0 PCIe card with external trigger
  - 1x CoaXPress Cable (3 m)
  - 1x Multi I/O Timing Cable (BNC to SMB: 1.5 m)

## Footnotes

1. Assembled in a state-of-the-art facility, Andor's UltraVac™ vacuum process combines a permanent hermetic vacuum seal (no o-rings), with a stringent protocol and proprietary materials to minimize outgassing. Outgassing is the release of trapped gases that would otherwise degrade cooling performance and potentially cause sensor failure.
2. Figures are typical and target specifications and therefore subject to change.
3. Quantum efficiency as supplied by the sensor manufacturer.
4. Coolant temperature must be above dew point.
5. Linearity is measured from a plot of Signal vs. Exposure Time over the full dynamic range.
6. Software Exposure Events provide rapid software notification (SDK only) of the start and end of acquisition.
7. The Sona connects to your control PC using a USB 3.0 connection. This may also be referred to as USB 3.1 (Gen 1). Andor provide a USB 3.0 card and cable, and recommend that these are used to ensure optimum performance.

[andor.com](http://andor.com)

## Minimum Computer Requirements:

- 3.0 GHz single core or 2.4 GHz dual or quad core processor
- 8 GB RAM
- Hard drive: 850 MB/sec write speed recommended for the data rate associated with the max. frame rates. 250 MB free hard disc to install software
- USB 3.0 slot (or x4 PCIe slot for USB 3.0 card)
- x8 PCIe slot for CXP PCIe card
- Windows (8, 8.1 and 10) or Linux

## Operating & Storage Conditions:

- Operating Temperature: 0°C to +30°C ambient
- Operating Altitude: up to 6000 m
- Relative Humidity: <70% (non-condensing)
- Storage Temperature: -10°C to 50°C

## Power Requirements:

- 100 - 240 VAC, 50 - 60 Hz
- Power consumption: 40 - 46 W typical / 114W max (model dependent)



Windows is a registered trademark of Microsoft Corporation.  
Labview is a registered trademark of National Instruments.  
Matlab is a registered trademark of The MathWorks Inc.