



Back Illuminated Scientific CMOS

Discovery depends on every photon

Prime 95B is the Scientific CMOS with extreme sensitivity using high Quantum Efficiency (QE) Backside Illumination (BSI), a first for Scientific CMOS cameras. The 95B's sensor converts up to 95% of incident photons into a measurable signal. Unlike microlens approaches to increasing QE, which lose effectiveness as objective magnification is increased, Prime 95B's BSI sensor brings light into the pixel photodiode from behind, avoiding structures that reflect or absorb light. When combined with large 11µm pixels, Prime 95B can deliver over 300% more signal than other sCMOS cameras at 100X magnification.

More importantly, Prime 95B outperforms EMCCD cameras—with no excess noise that negates the benefit of using a high QE sensor, and additional limitations from EM gain calibration, stability, expense, and sensor lifetime. With a true 16-bit dynamic range, Prime 95B easily accomplishes what EMCCD can not—detect weak and bright signals within the same image with photon-noise limited performance.

The extreme sensitivity not only allows fainter signals to be detected, it provides the flexibility to increase frame rates, or turn down the excitation intensity to reduce cellular photo-damage. Yet Prime 95B maintains the same high frame rates, field-of-view and extremely low read noise that has made sCMOS so popular for live-cell imaging.



Primary applications:

[Super-Resolution Microscopy](#)

[Confocal Microscopy](#)

[Single Molecule Fluorescence](#)

[Light Sheet Microscopy](#)

- ▶ 95% Quantum Efficiency
- ▶ 11µm x 11µm Pixel Area
- ▶ 1.6e- Read Noise (median)
- ▶ 41fps @ 16-bit / 82fps @ 12-bit
- ▶ PrimeEnhance increases SNR 3-5X

Features	Advantages
High Quantum Efficiency 95% Peak QE	Maximizes ability to detect weak signals, enables short exposure times for high frame rates, minimizes phototoxicity across a wide range of wavelengths
Large 11µm Pixel Size	Maximize light collection while maintaining proper spatial sampling
Extremely Low Read Noise	Maximize your ability to detect faint fluorescence
Fast Frame Rates	Capture highly dynamic events with high temporal resolution
Large Field of View	Maximize the number of cells that can be tracked and monitored per frame
Prime Enhance™	Real-time quantitative denoising algorithm that improves image clarity by reducing photon-shot (Poisson) noise. Delivers an increase in Peak Signal to Noise Ratio of 3x to 5x
PrimeLocate™	Dynamically evaluates and acquires only the relevant data for localization based super-resolution applications
Enhanced Dynamic Range	Measure both bright and dim signal levels within the same image 50,000:1 Dynamic Range (94 dB)
Multiple Expose Out Triggering	Control up to four light sources for multi-wavelength acquisitions
SMART Streaming™	Faster acquisition rates with variable exposures, ideal for multi-probed live cell imaging Compatible with Multiple Expose Out Triggering

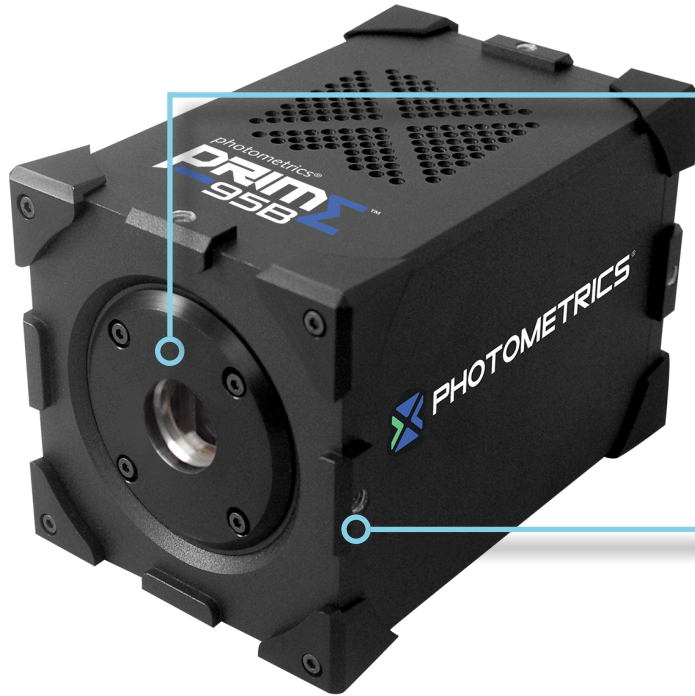

1.4 Megapixel BSI CMOS Sensor

Backside Illuminated Sensor
 1.6e- Read Noise (Median)
 >95% peak QE
 80,000e- full well
 11 x 11µm pixels
 18.7mm diagonal

Easily Mounted and Secured

C-Mount
 Two ¼" -20 mounting holes per side

Convenient Interfaces

- 16-bit Data
 - 41 fps
- 12-bit Data
 - 82 fps

Multiple Cooling Options

- Forced Air Cooling
 - -20°C Cooling
 - Selectable Fan Speed
- Liquid Cooling
 - -25°C Cooling
 - Leak-proof, quick-disconnect ports

Advanced Application Triggers

- Effective Global Shutter
- Up to four selectable expose-out lines



Real-Time Application Optimization

PrimeEnhance™

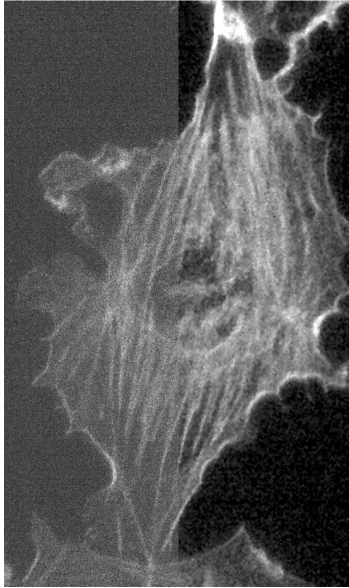

With the near-perfect sensitivity of Backside Illuminated Scientific CMOS sensors, the latest generation of scientific cameras have enabled imaging using only a few photons per pixel. Unfortunately, these minute signals are dominated by the natural Poisson variation in light levels preventing useful quantitation.

PrimeEnhance uses a quantitative SNR enhancement algorithm used in Life Science imaging to reduce the impact of photon shot-noise present in acquired images, leading to an increase in Signal to Noise Ratio (SNR) by 3x to 5x with equivalent exposure times.

With PrimeEnhance, the exposure times can be reduced by a factor of 8-10x while maintaining the Signal to Noise ratio. This reduces the effects of cellular photo-damage and extends cell lifetimes.

Invented at INRIA and further optimized for fluorescence microscopy at the Institut Curie, the denoising algorithm used in PrimeEnhance uses a patch based evaluation of image data and knowledge of the each individual camera's performance parameters to reduce the effects of photon shot-noise. The patches of image intensities and their noise characteristics are processed and evaluated with increasing neighborhood sizes during which weighted intensity averages are taken. This iterative process preserves not only the quantitative nature of the measured intensities, but also the maintains the finer features present in biological samples.

- ▶ Increase SNR 3x to 5x at low light levels by reducing photon shot-noise
- ▶ Preserve signal intensities ensuring quantitative measurements
- ▶ Extend cell lifetimes with reduced phototoxicity and photobleaching
- ▶ Extremely useful for low light imaging applications dominated by noise

Detailed performance and methodology of the algorithm is available in the following publication:

Patch-based nonlocal functional for denoising fluorescence microscopy image sequences.

Boulanger J, Kervrann C, Bouthemy P, Elbau P, Sibarita JB, Salamero J. *IEEE Trans. Med Imaging* 2010 Feb.

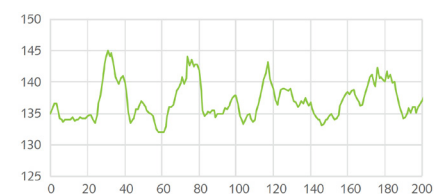
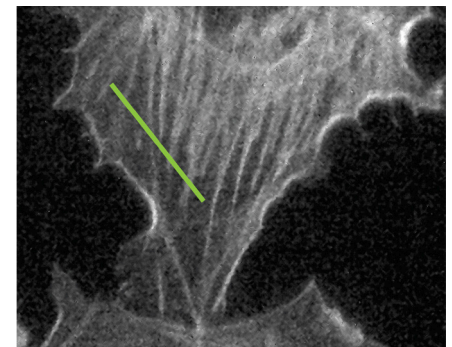
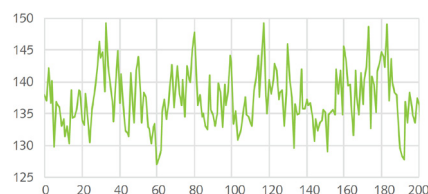
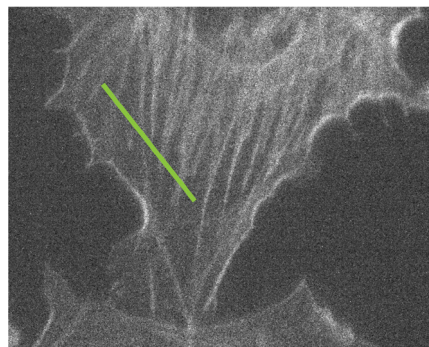

Real-Time Application Optimization

PrimeLocate™

Localization based super-resolution microscopy requires a sparsity of data to ensure proper localization of emitting molecules. Even with this sparsity, the full image frame is transferred to the host computer to be analyzed, creating a large amount of data to be processed without adding useful information.

PrimeLocate dynamically evaluates image data and locates 500 regions per frame containing single molecule data relevant for super-resolution localization. Only these 500 regions are transferred to the host computer, drastically reducing the amount of data and time required for analysis.

By transferring only the relevant raw data, users have the freedom to use their preferred localization algorithm to generate super-resolution images.

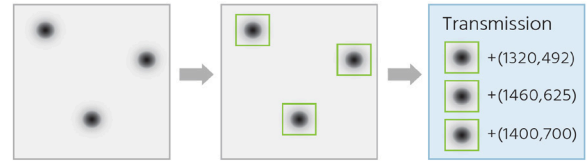

- ▶ Only the data within the patches is transferred to the host computer
- ▶ Processing time and storage requirements are easier to manage with the acquisition of only relevant data
- ▶ Ability to transfer 500 regions per frame
- ▶ Allows freedom to select preferred super-resolution localization algorithm

Multi-ROI

The surplus of data generated by sCMOS devices is challenging to acquire, analyze, and store, requiring special interfaces and expensive SSDs. While a large Field of View (FOV) is convenient for imaging, at times, only certain areas contain the desired information.

Multi-ROI allows users to select up to 15 unique ROIs within the FOV, and only these selected regions are transferred to the host computer. This allows for a large reduction in the amount of data acquired but ensures that the critical information is obtained.

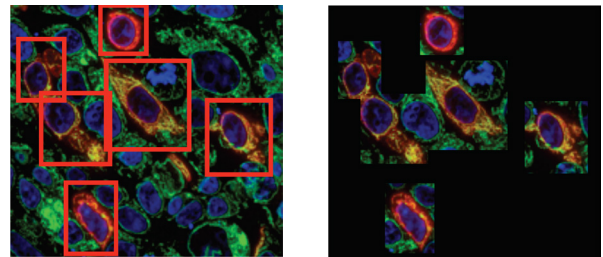

- ▶ Only the data within the user-defined ROIs is transferred to the host computer
- ▶ Select up to 15 unique regions
- ▶ Significantly reduce the amount of data being acquired

Real-Time Application Optimization

Live Particle Tracking

Single molecule tracking is a technique often used to observe molecular interactions and behaviours at the single molecule level with high spatial and temporal resolution.

Teledyne Photometrics Live Particle Tracking performs this process live on the camera with live statistics.

The Live Particle Tracking algorithm works by identifying individual single molecule particles and tracking them across the field of view by adapting a published algorithm¹ tuned for two-dimensional tracking.

Firstly, the camera determines only the dynamic portions of the image and disqualifies anything static from detection. The data is then run through a restoration step (Figure 1) which reduces both the high frequency and low-frequency noise, and allows the correction of any noise variation on a pixel-to-pixel basis as well as any background intensity modulations due to uneven illumination.

The points are then processed to determine the local-maxima and go through a refinement process to ensure a high efficiency in particle detection based on a threshold to reduce the susceptibility to false positives. Any remaining artifacts are filtered out during the non-particle discrimination step, aimed at hot pixels and cosmic events.

The particles are tracked and linked through the acquired frame stack. The metadata included with all images is updated to include the particle data within each frame, providing particle IDs as well as the ability to display particle path traces as well as boxes to outline each detected particle.

Live Particle Tracking can be used to determine whether the particles are behaving as expected before time consuming data acquisition for post-processing tracking analysis.

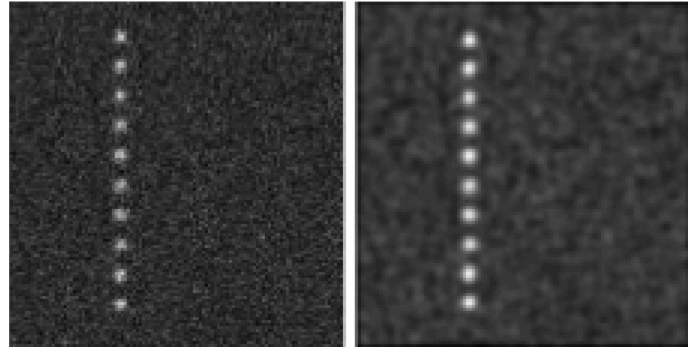

Figure 1: The input image of simulated single-particle data and the output of the image-restoration step to reduce image noise and pixel-to-pixel variation

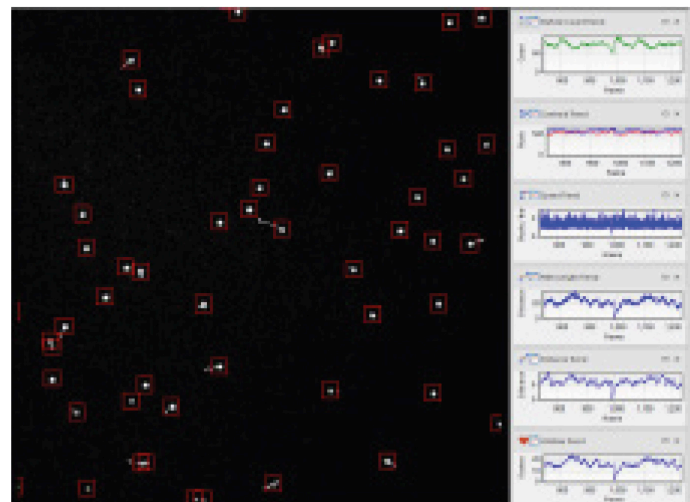

Figure 2: Live Particle Tracking running in Ocular software. Movement information of each particle is recorded, allowing tracking statistics to be displayed

¹ I.F.Sbalzarini & P. Koumoutsakos. (2005)

Feature point tracking and trajectory analysis for video imaging in cell biology. *J Struct Bio.* Aug;151(2):182-95.

Three Field Of View Options

Most modern microscope camera ports have a maximum field of view of 19 mm, 22 mm or, more recently, 25 mm. The Prime 95B Series is uniquely positioned to match each of these ports to deliver the largest obtainable field of view for imaging.

The Prime 95B and Prime 95B 22mm connect via the standard microscope C-mount and the Prime 95B 25mm connects via the larger format F-mount.

- ▶ Match the Prime 95B to the largest available microscope port
- ▶ Maximize field of view
- ▶ Increase throughput and maximize sample imaging area

Prime 95B

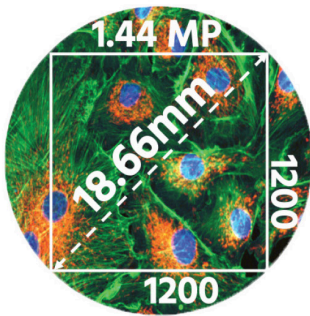

Prime 95B 22mm

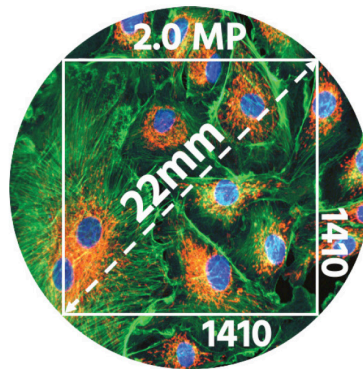

Prime 95B 25mm

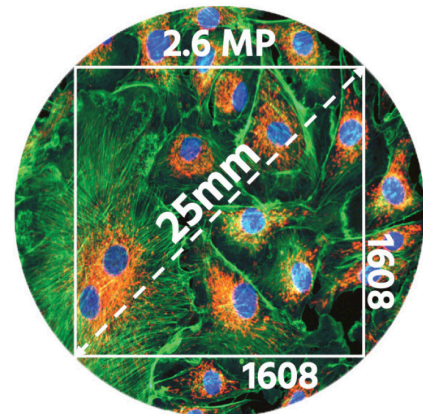

UV Sensor Variant

Maximize sensitivity in the UV with the Prime 95B UV (250-310 nm). Capture more photons than before at this difficult wavelength to reduce exposure times and increase speeds.

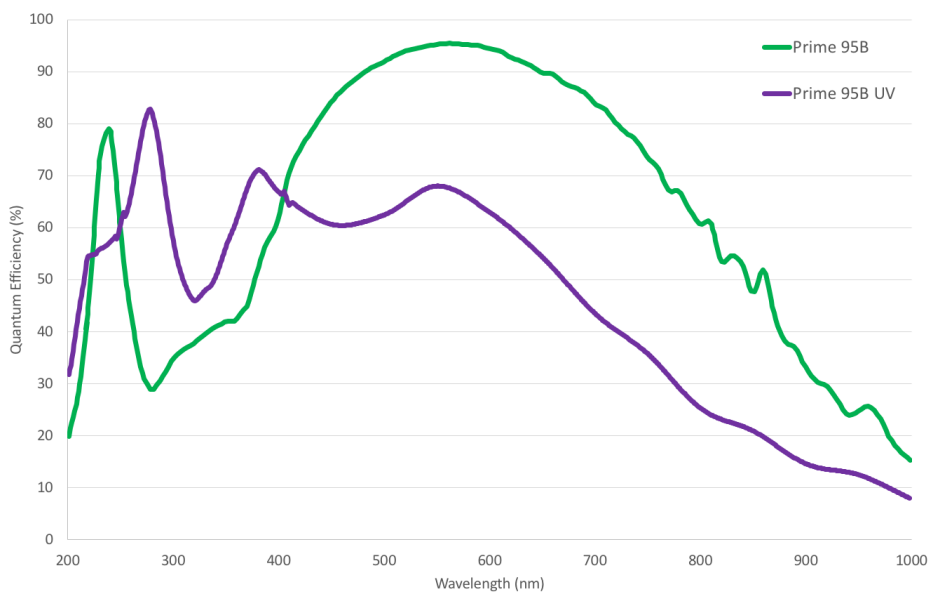

Specifications	Camera Performance
Sensor	GPixel GSense 144 BSI CMOS Gen IV, Grade 1 in imaging area
Active Array Size	1200 x 1200 pixels (1.44 Megapixel)
Pixel Area	11µm x 11µm (121µm ²)
Sensor Area	13.2mm x 13.2mm 18.7mm diagonal
Peak QE%	>95%
Read Noise	1.6e- (Median) 1.8e- (RMS)
Full-Well Capacity	80,000e- (Combined Gain) 10,000e- (High Gain)
Dynamic Range	50,000:1 (Combined Gain)
Bit Depth	16-bit (Combined Gain) 12-bit (High Gain)
Readout Mode	Rolling Shutter Effective Global Shutter
Binning	2x2 (on FPGA)
Linearity	>99.5%

Cooling Performance	Sensor Temperature	Dark Current
Air Cooled	-20°C @ 25°C Ambient	0.55e-/pixel/second
Liquid Cooled	-25°C @ 25°C Ambient	0.3e-/pixel/second

Specification	Camera Interface
Digital Interface	PCIe, USB 3.0
Lens Interface	C-Mount
Mounting Points	2x 1/4 "-20 mounting points per side to prevent rotation
Liquid Cooling	Quick Disconnect Ports

Triggering Mode	Function
Input Trigger Modes	Trigger First: Sequence triggered on first rising edge Edge: Each frame triggered on rising edge SMART Streaming: Fast iteration through multiple exposure times
Output Trigger Modes	First Row: Expose signal is high while first row is acquiring data Any Row: Expose signal is high while any row is acquiring data All Rows: Effective Global Shutter – Expose signal is high when all rows are acquiring data Signal is high for set Exposure time Rolling Shutter: Effective Global Shutter – Expose signal is high when all rows are acquiring data Signal is High for set Exposure time – Readout Time
Output Trigger Signals	Expose Out (up to four signals), Read Out, Trigger Ready

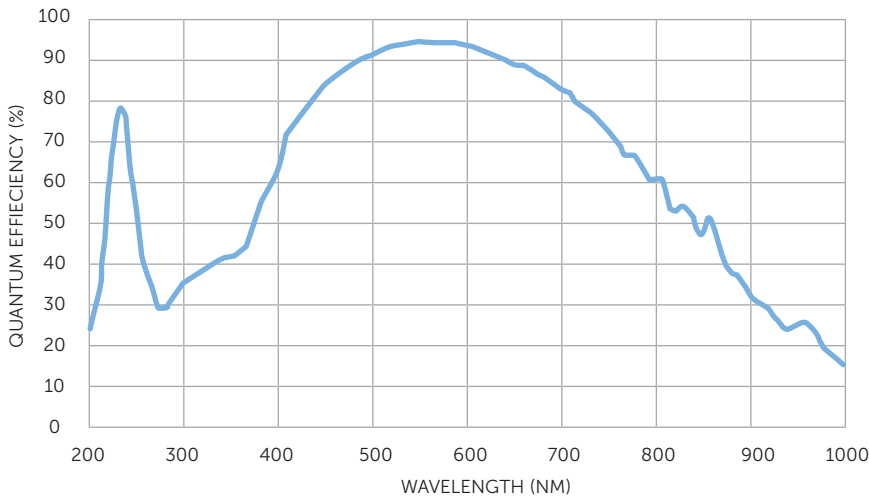

Frame Rate (PCIe interface)		
Array Size	16-bit	12-bit
1200 x 1200	41	82
1200 x 512	96	192
1200 x 256	192	384
1200 x 128	384	736

Accessories (Included)

- PCIe Card/Cable
- Power Supply
- USB 3.0 Cable
- Manuals and QuickStart Guide
- Trigger Cables
- Performance and Gain Calibration Test Data

Accessories (Additional)

- Liquid Circulator
- Liquid Cooling Tubes

Distance from C-mount to sensor

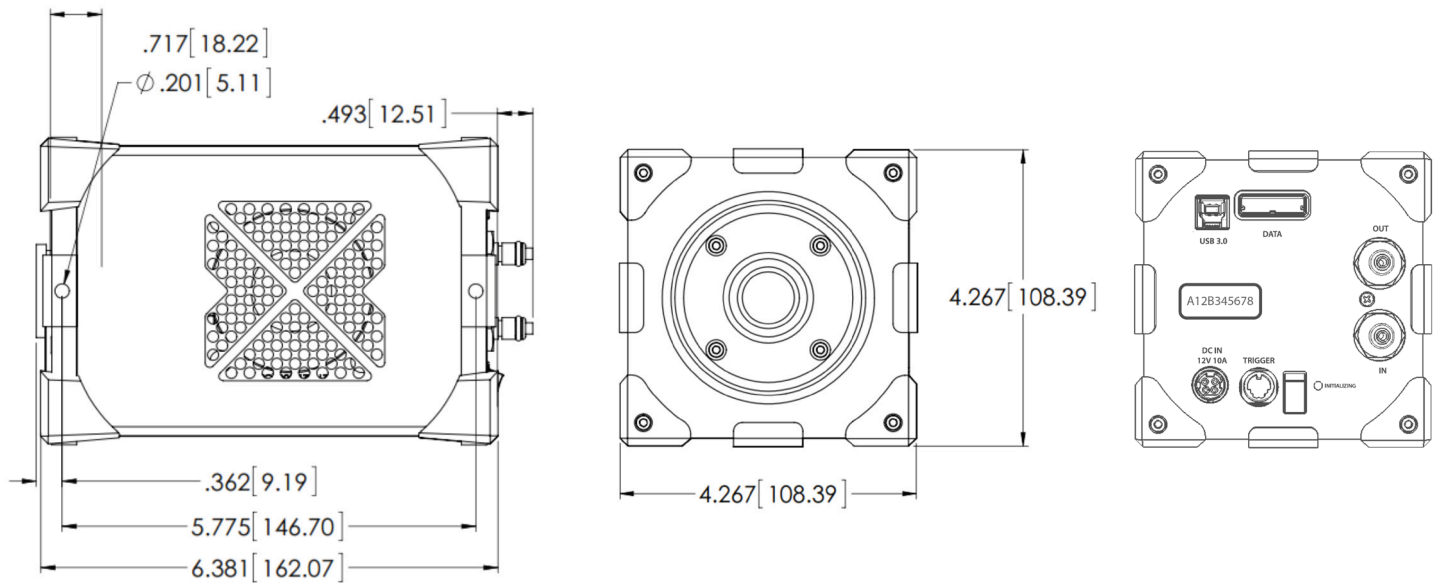

Teledyne Photometrics is a registered trademark. Prime 95B is a trademark of Teledyne Photometrics. All other brand and product names are the trademarks of their respective owners.

Specifications in this datasheet are subject to change. Refer to the Teledyne Photometrics website for most current specifications.

